

SPECIFICATION

- Part No. : **MA460.K.LBIC.002**
- Product Name : MA460 Storm 4in1 Low Profile
Permanent Mount Combination Antenna
2*LTE MIMO, GPS/GLONASS/GALILEO/BeiDou and Wi-Fi
- Features : 2* LTE MIMO
698-960 / 1710-2170 / 2490-2690 / 3300-3600MHz
1* Wi-Fi 2.4GHz/5.8GHz
1* GPS-GLONASS-GALILEO-BeiDou Antenna
Permanent Screw Mount
Worldwide 4G Bands including 3G and 2G
Aerodynamic, Super Low-profile Vandal Resistant Housing
IP67 Enclosure
Dims: 216*93*31mm
3M CFD-200 and RG-174 with SMA(M) / RP-SMA(M)
connectors
Custom Cable Lengths and Connectors Available
RoHS Compliant



1. Introduction

The Storm MA460 antenna is a low profile, heavy-duty, fully IP67 waterproof external M2M antenna for use in worldwide telematics applications which require best in class LTE, GNSS, and Wi-Fi performance.

This unique product, at a height of only 31mm, delivers powerful worldwide 4G LTE MIMO antenna technology at 700/800/1700/1800/2600MHz, plus GPS-GLONASS-GALILEO-BeiDou for next generation location accuracy. The dual-band Wi-Fi antenna allows for excellent Wi-Fi performance.

Typical applications include:

- Internet of Things (IoT)
- Remote Asset and Pipeline Monitoring
- HD Video over LTE
- First Responder and Emergency Services
- Automotive Vehicle Tracking and Telematics

LTE 4G applications demand high speed data uplink and downlink. High efficiency and high gain MIMO antennas are necessary to achieve the required signal to noise ratio and throughput to solve these challenges. Taoglas also takes care to have high isolation between the two MIMO antennas to prevent self-interference. The MA460 does not require a ground plane. Low loss cables are used to keep efficiency high over long cable lengths. In contrast, smaller MIMO antennas with poorer quality thinner cables will have much reduced efficiency and isolation, which would lead to a large drop in system throughput or drops, and may not make a system connection at all.

The GPS-GLONASS-GALILEO-BeiDou active antenna has been carefully designed for excellent performance across all bands, leading to higher location accuracy and stability of tracking in urban environments.

Cable length and connector types are customizable. Contact your regional Taoglas sales office for support.

Conformity is declared under the following standard: **EN55022 Class B**

This is to declare that the product listed above conform to the EMC directive 2014/30/EU.

2. Specification

GPS-GLONASS-GAILEO-BeiDou Antenna				
Center Frequency	GPS/GALILEO: 1575.42±1.023MHz GLONASS: 1602±5MHz BeiDou: 1561.098±2.046MHz			
Passive Antenna Efficiency (with cable loss)	GPS/GALILEO: 27% GLONASS: 32% BeiDou: 32%			
Passive Antenna Average gain (with cable loss)	GPS/GALILEO: -5.5dBi GLONASS: -4.8dBi BeiDou: -4.8dBi			
Passive Antenna Peak gain (with cable loss)	GPS/GALILEO: 0.9dBi GLONASS: 0.6dBi BeiDou: 1.0dBi			
VSWR	2:1 Max			
Impedance	50Ω			
Axial Ratio	GPS/GALILEO: <12.48 GLONASS: <12.33 BeiDou: <17.03			
Polarization	RHCP			
Cable	3 meters RG-174 standard, fully customizable			
Connector	SMA(M) standard, fully customizable			
LNA and Filter Electrical Properties				
Center Frequency	GPS/GALILEO: 1575.42±1.023MHz GLONASS: 1602±5MHz BeiDou: 1561.098±2.046MHz			
Pout 1dB gain Compression point	-6dBm Min. -2dBm Typ. (1561MHz, 1575.42MHz, 1602MHz)			
Output Impedance	50Ω			
VSWR	< 2:1			
Return Loss	10 dB Min.			
LNA Gain, Current Draw, and Noise Figure @GPS	Voltage	LNA Gain (Typ)	Current Draw (Typ)	Noise Figure (Typ)
	Min 1.8V	19dB	5mA	2.4dB
	Typ 3.0V	27dB	10mA	2.7dB
	Max 5.5V	30dB	23mA	3.1dB
Total Specification (Through Antenna, SAW Filter, and LNA)				
Frequency	1561.098±2.046MHz	1575.42±1.023MHz	1602±5MHz	
Gain@3V	1561MHz: 29±3dBi	1575.42MHz: 29±3dBi	1602MHz: 32±3dBi	
Output Impedance	50Ω			

4G/3G/2G LTE Antenna									
Frequency (MHz)		LTE700	GSM850	GSM900	DCS	PCS	UMTS1	LTE2600	LTE3500
		698~803	824~894	880~960	1710~1880	1850~1990	1920~2170	2490~2690	3300~3600
Efficiency (%)									
MIMO_1	30cm	41.15	34.38	41.39	65.93	42.47	41.42	44.70	51.91
	1M	38.97	32.83	39.52	60.13	38.74	38.05	40.76	46.02
	2M	36.37	30.12	36.05	53.59	34.14	33.38	35.20	38.94
	3M	33.71	27.94	33.39	47.67	30.17	29.48	30.50	32.97
	5M	29.09	23.78	28.23	37.61	23.68	22.98	22.88	23.62
MIMO_2	30cm	53.42	35.10	39.18	69.08	51.06	44.92	47.27	45.91
	1M	50.50	33.52	37.42	63.00	46.57	41.27	43.11	40.74
	2M	47.13	30.76	34.13	56.15	41.04	36.16	37.23	34.50
	3M	43.75	28.53	31.62	49.94	36.26	31.97	32.23	29.18
	5M	37.75	24.28	26.73	39.38	28.47	24.94	24.19	20.94
Average Gain (dBi)									
MIMO_1	30cm	-3.98	-4.65	-3.86	-1.86	-3.77	-3.88	-3.54	-2.87
	1M	-4.22	-4.85	-4.06	-2.26	-4.17	-4.25	-3.94	-3.39
	2M	-4.52	-5.22	-4.46	-2.76	-4.73	-4.82	-4.58	-4.12
	3M	-4.85	-5.55	-4.79	-3.27	-5.26	-5.35	-5.21	-4.84
	5M	-5.48	-6.25	-5.52	-4.30	-6.32	-6.44	-6.45	-6.29
MIMO_2	30cm	-2.86	-4.56	-4.08	-1.62	-2.97	-3.50	-3.26	-3.46
	1M	-3.11	-4.76	-4.28	-2.02	-3.37	-3.87	-3.66	-3.98
	2M	-3.41	-5.13	-4.68	-2.52	-3.93	-4.44	-4.30	-4.71
	3M	-3.74	-5.46	-5.01	-3.03	-4.46	-4.97	-4.93	-5.43
	5M	-4.37	-6.16	-5.74	-4.07	-5.52	-6.06	-6.17	-6.88
Peak Gain (dBi)									
MIMO_1	30cm	2.05	0.97	2.16	6.88	5.62	4.81	5.37	4.41
	1M	1.85	0.77	1.96	6.48	5.22	4.41	4.97	4.41
	2M	1.55	0.37	1.56	5.98	4.72	3.91	4.37	3.71
	3M	1.25	0.07	1.16	5.48	4.22	3.31	3.77	3.01
	5M	0.55	-0.63	0.46	4.48	3.12	2.31	2.57	1.61
MIMO_2	30cm	2.56	0.58	0.90	6.69	5.85	5.42	6.09	5.33
	1M	2.36	0.38	0.70	6.29	5.45	5.02	5.69	4.83
	2M	2.06	-0.02	0.30	5.79	4.95	4.52	5.09	4.13
	3M	1.76	-0.32	-0.10	5.29	4.45	3.92	4.44	3.43
	5M	1.06	-1.02	-0.80	4.29	3.35	2.92	3.19	2.03
Envelope Correlation Coefficient				All bands < 0.3					
Impedance				50Ω					
Polarization				Linear					
VSWR				< 3					
Cable				3 meters CFD-200 standard, fully customizable					
Connector				SMA(M) standard, fully customizable					

2.4GHz/5.8GHz Wi-Fi Antenna		
Frequency (MHz)	2400~2500	4900~5850
Efficiency (%)		
30cm	68.43	56.73
1M	62.41	48.80
2M	54.36	39.53
3M	47.34	32.06
5M	35.91	21.05
Average Gain(dBi)		
30cm	-1.66	-2.48
1M	-2.06	-3.14
2M	-2.66	-4.05
3M	-3.26	-4.96
5M	-4.46	-6.79
Peak Gain(dBi)		
30cm	5.37	6.68
1M	5.37	6.68
2M	4.77	5.78
3M	4.17	4.88
5M	2.97	3.18
Impedance	50Ω	
Polarization	Linear	
VSWR	< 2	
Cable	3 meters CFD-200 standard, fully customizable	
Connector	RP-SMA(M) standard , fully customizable	

MECHANICAL	
Antenna Dimensions	216.24*93.25*30.95mm
Casing	ABS+PC
Base and thread	Nickel Plated Aluminum
Weight (including cable)	1120g
Ingress Protection Rating	IP67
Maximum Assembly Torque	39.2 N-m
ENVIRONMENTAL	
Operation Temperature	-40°C to 85°C
Storage Temperature	-40°C to 90°C
Humidity	Non-condensing 65°C 95% RH

LTE BANDS				
Band Number	LTE / LTE-Advanced / WCDMA / HSPA / HSPA+ / TD-SCDMA			
	Uplink	Downlink	MIMO 1	MIMO 2
1	UL: 1920 to 1980	DL: 2110 to 2170	✓	✓
2	UL: 1850 to 1910	DL: 1930 to 1990	✓	✓
3	UL: 1710 to 1785	DL: 1805 to 1880	✓	✓
4	UL: 1710 to 1755	DL: 2110 to 2155	✓	✓
5	UL: 824 to 849	DL: 869 to 894	✓	✗
7	UL: 2500 to 2570	DL: 2620 to 2690	✓	✓
8	UL: 880 to 915	DL: 925 to 960	✓	✓
9	UL: 1749.9 to 1784.9	DL: 1844.9 to 1879.9	✓	✓
11	UL: 1427.9 to 1447.9	DL: 1475.9 to 1495.9	✗	✗
12	UL: 699 to 716	DL: 729 to 746	✓	✓
13	UL: 777 to 787	DL: 746 to 756	✓	✓
14	UL: 788 to 798	DL: 758 to 768	✓	✓
17	UL: 704 to 716	DL: 734 to 746 (LTE only)	✓	✓
18	UL: 815 to 830	DL: 860 to 875 (LTE only)	✓	✓
19	UL: 830 to 845	DL: 875 to 890	✓	✓
20	UL: 832 to 862	DL: 791 to 821	✓	✓
21	UL: 1447.9 to 1462.9	DL: 1495.9 to 1510.9	✗	✗
22	UL: 3410 to 3490	DL: 3510 to 3590	✓	✓
23	UL: 2000 to 2020	DL: 2180 to 2200 (LTE only)	✓	✓
24	UL: 1625.5 to 1660.5	DL: 1525 to 1559 (LTE only)	✓	✓
25	UL: 1850 to 1915	DL: 1930 to 1995	✓	✓
26	UL: 814 to 849	DL: 859 to 894	✓	✓
27	UL: 807 to 824	DL: 852 to 869 (LTE only)	✓	✓
28	UL: 703 to 748	DL: 758 to 803 (LTE only)	✓	✓
29	UL: -	DL: 717 to 728 (LTE only)	✓	✓
30	UL: 2305 to 2315	DL: 2350 to 2360 (LTE only)	✓	✓
31	UL: 452.5 to 457.5	DL: 462.5 to 467.5 (LTE only)	✗	✗
32	UL: -	DL: 1452 - 1496	✗	✗
35		1850 to 1910	✓	✓
38		2570 to 2620	✓	✓
39		1880 to 1920	✓	✓
40		2300 to 2400	✓	✓
41		2496 to 2690	✓	✓
42		3400 to 3600	✓	✓
43		3600 to 3800	✗	✗

*Covered bands represent an efficiency greater than 20%

3. Antenna Characteristics

3.1. GPS-GLONASS-GALILEO-BeiDou Antenna

3.1.1. Block Diagram (Active antenna)

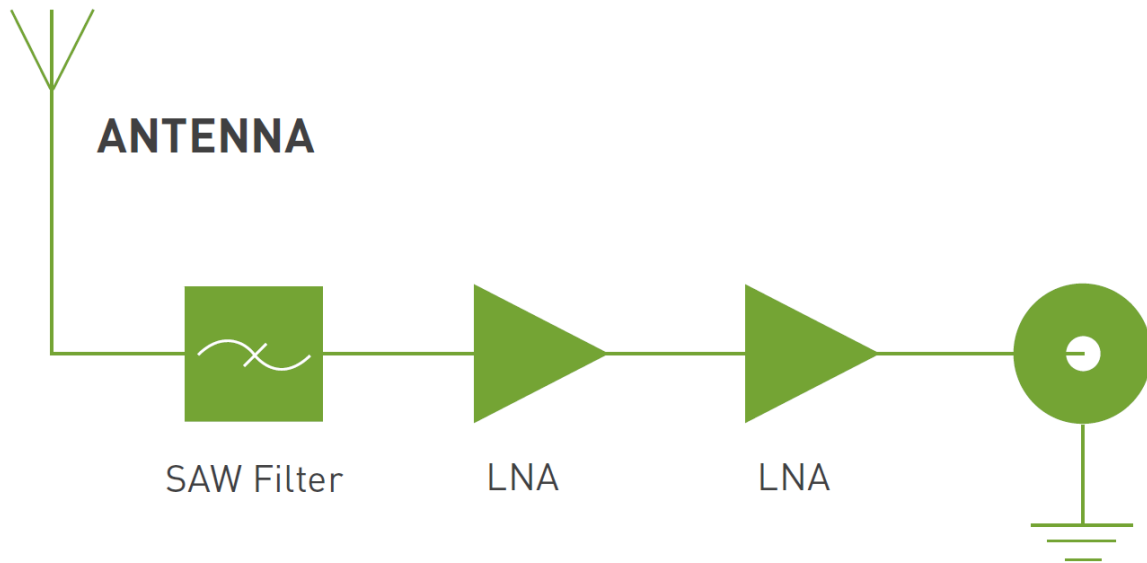

3.1.2. Test Setup



XZ Plane

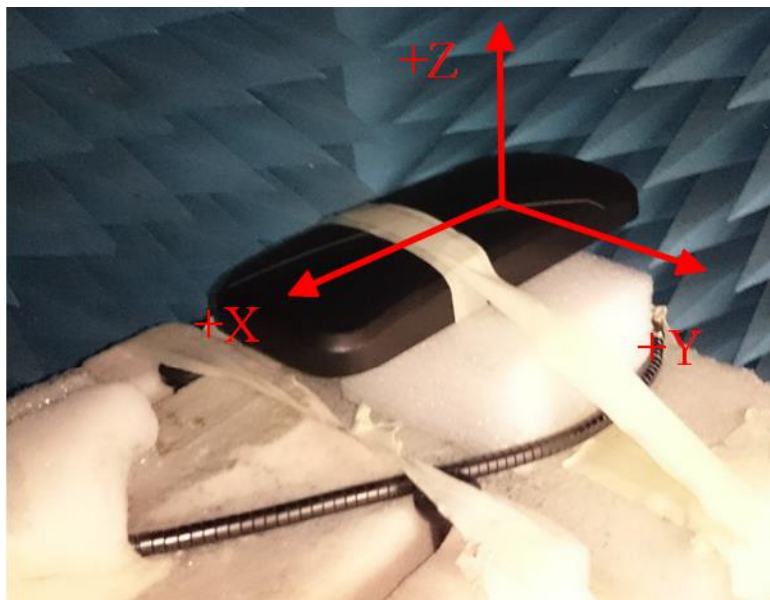

YZ Plane

3.1.3. GPS-GLONASS-GALILEO-BeiDou Return Loss (Passive antenna)

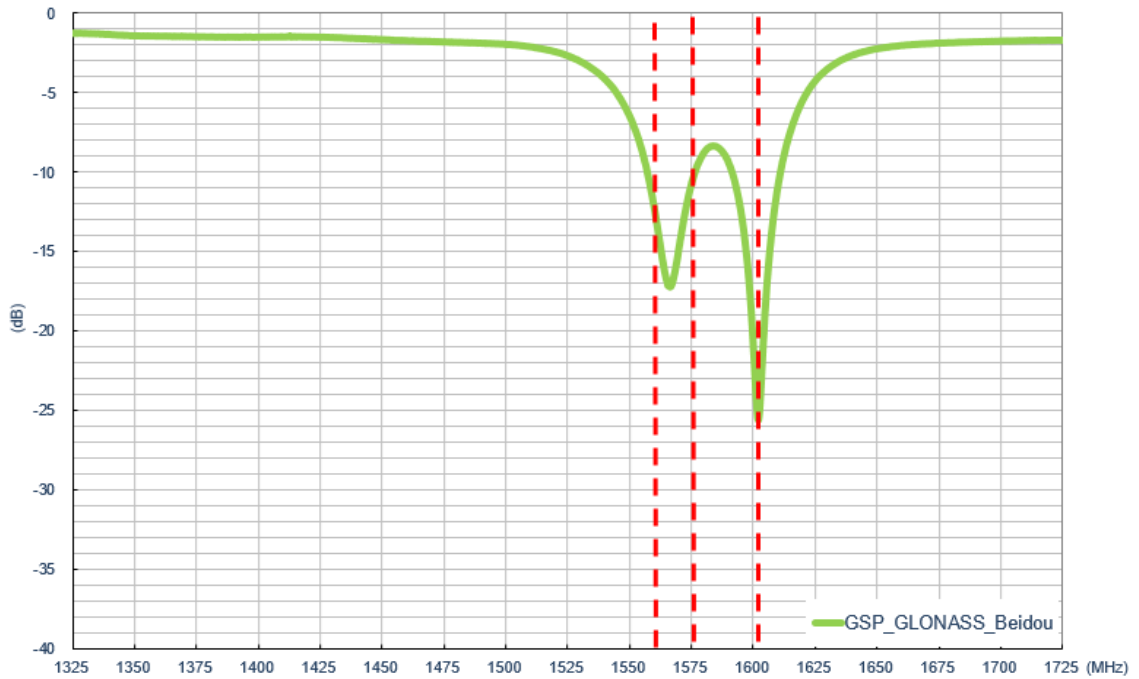

3.1.4. GPS-GLONASS-GALILEO-BeiDou VSWR (Passive antenna)

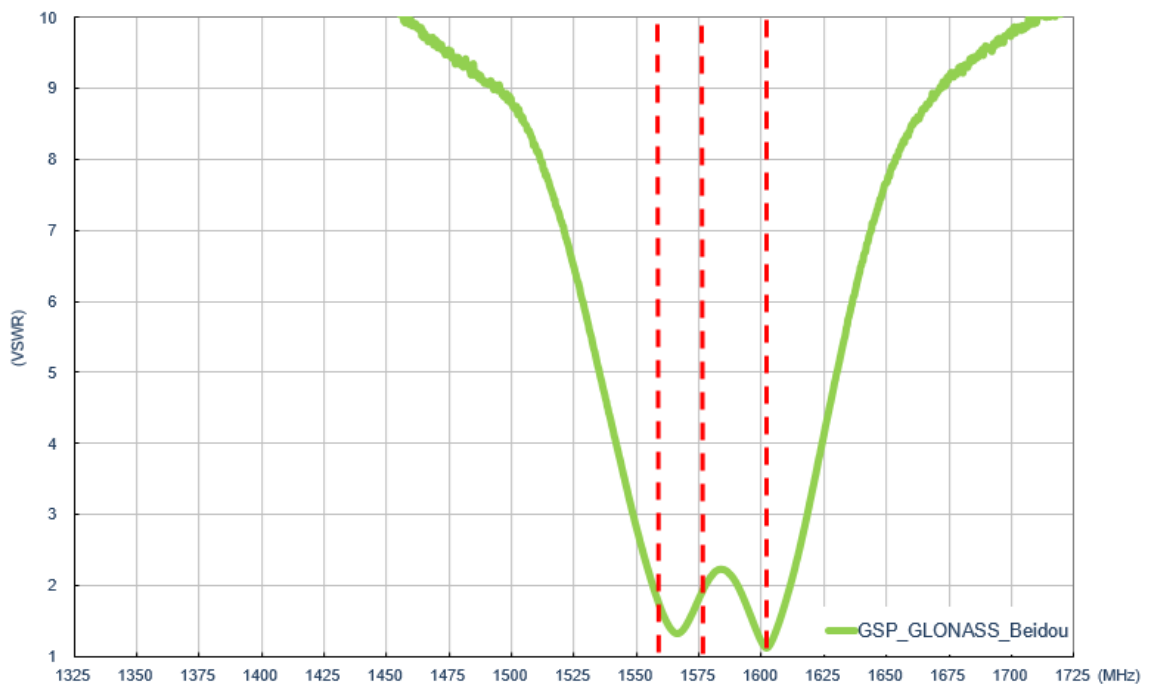

3.1.5. GPS-GLONASS-GALILEO-BeiDou Smith Chart (Passive antenna)

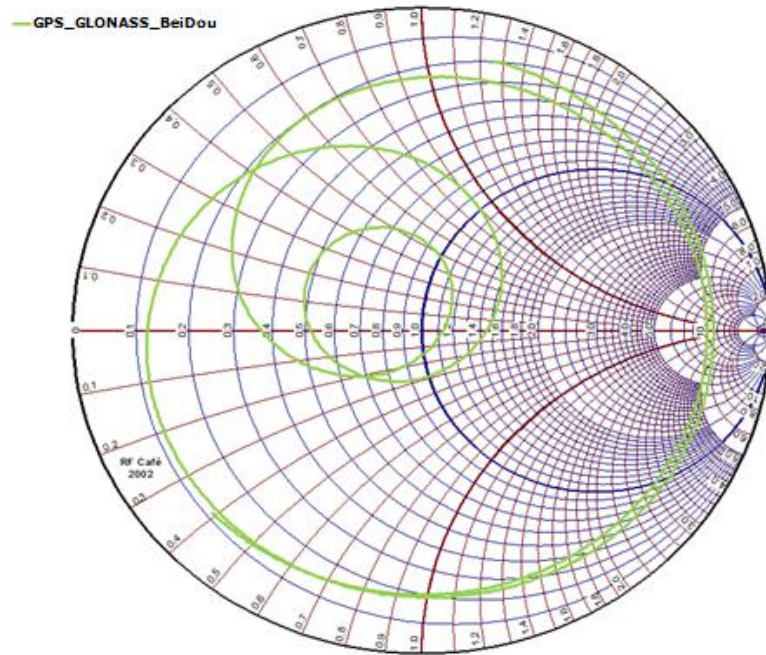

3.1.6. GPS-GLONASS-GALILEO-BeiDou Efficiency (Passive antenna)

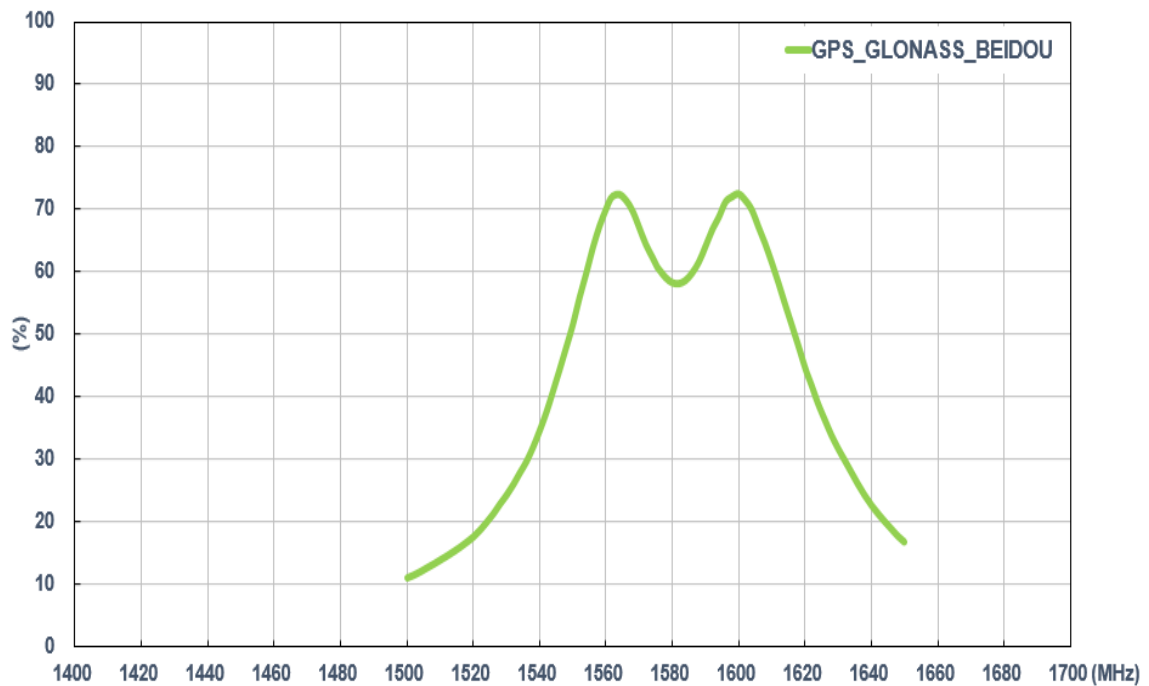

3.1.7. GPS-GLONASS-GALILEO-BeiDou Average Gain (Passive antenna)

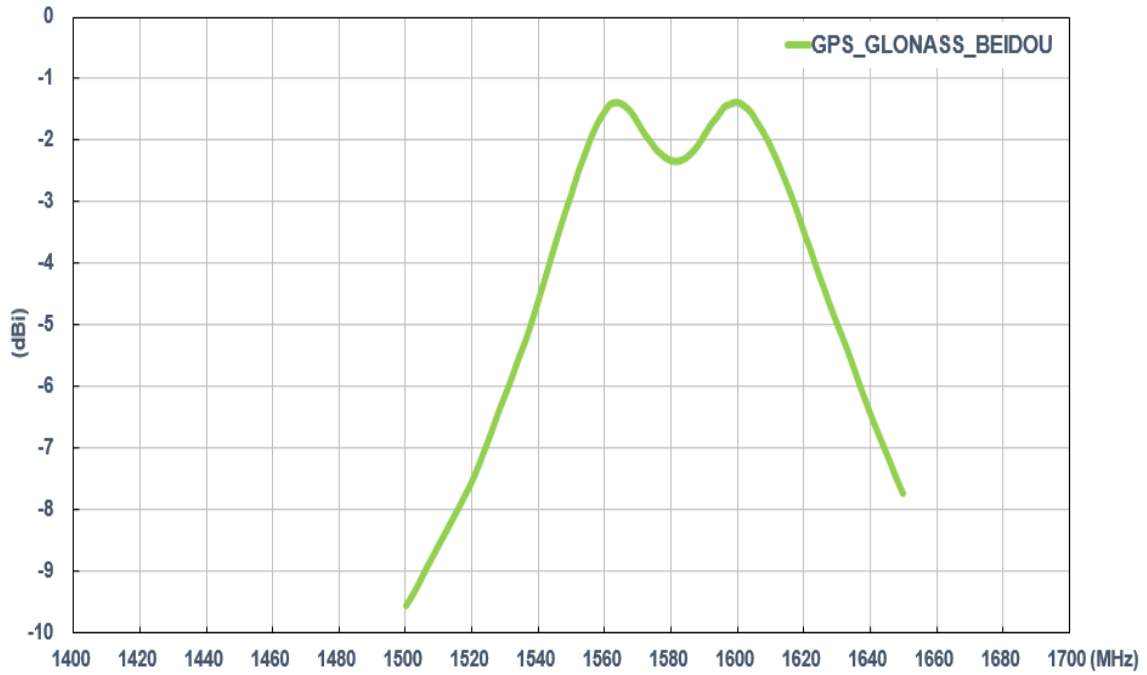

3.1.8. GPS-GLONASS-GALILEO-BeiDou Peak Gain (Passive antenna)

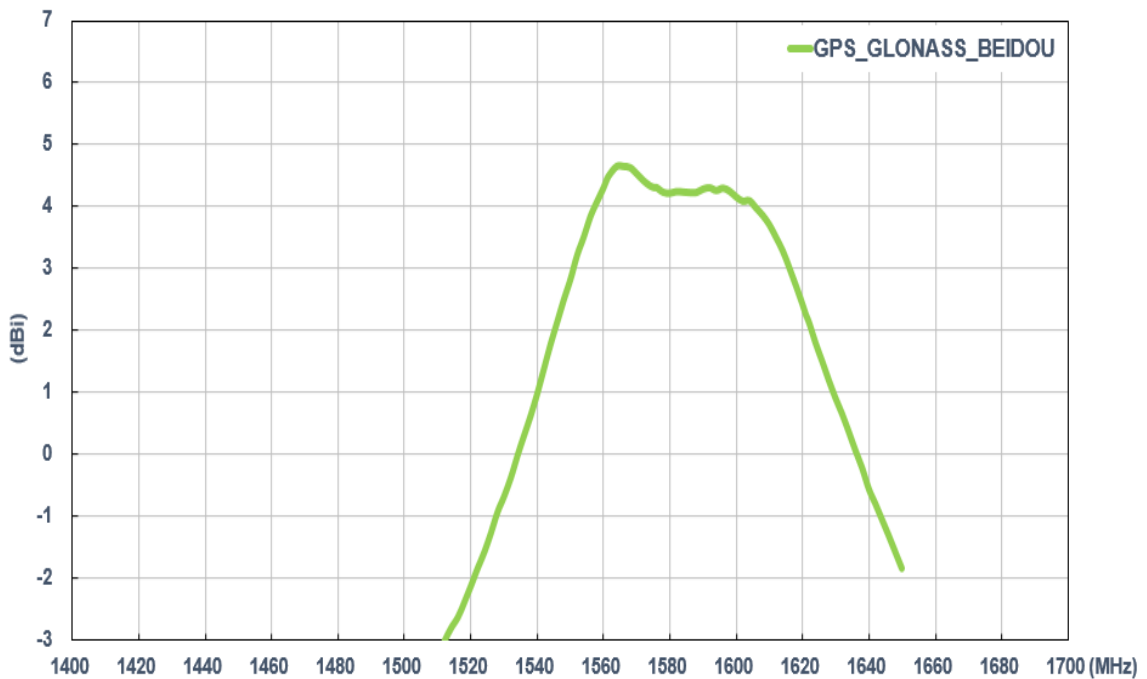

3.1.9. GPS-GLONASS-GALILEO-BeiDou Radiation Pattern (Passive antenna)

3.1.9.1. 2D Radiation pattern

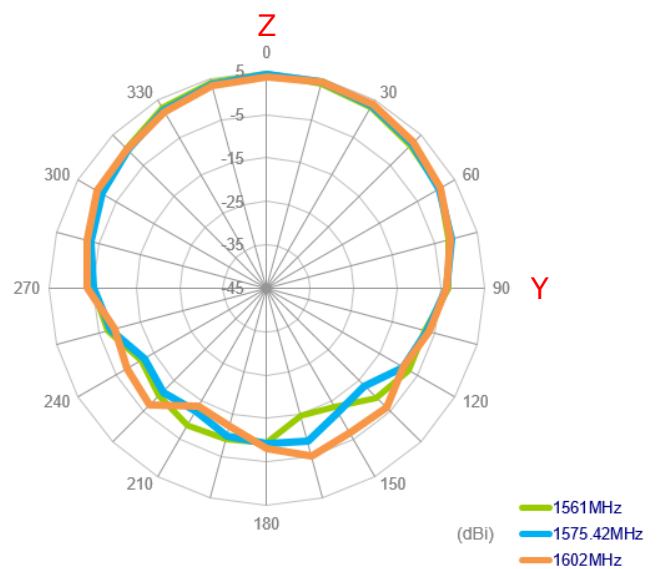
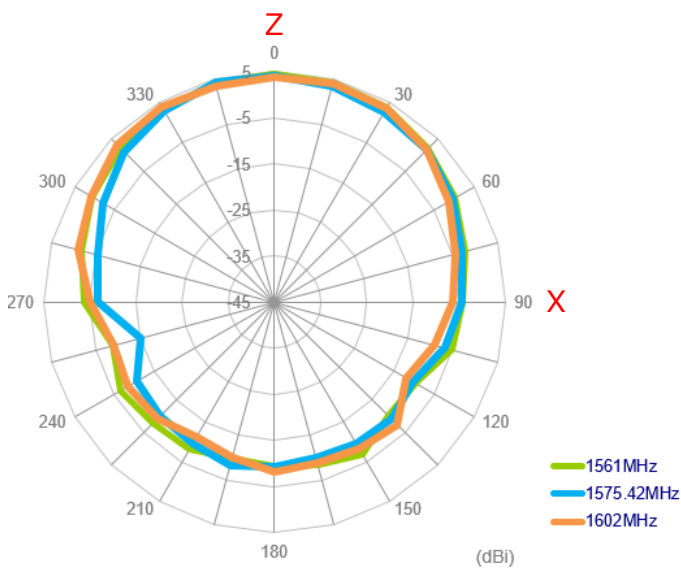
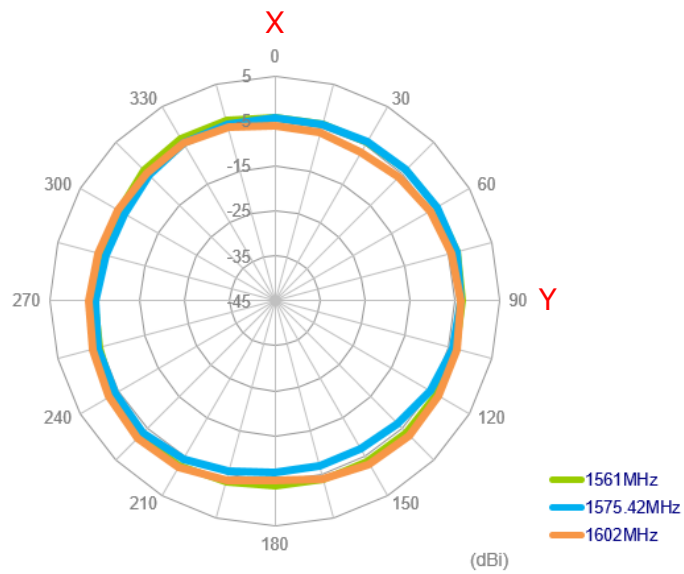

3.1.9.2. 3D Radiation Pattern (Passive antenna)

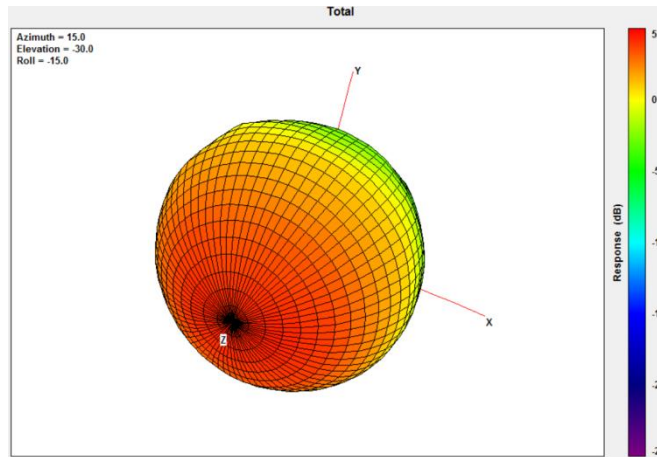

@1561MHz

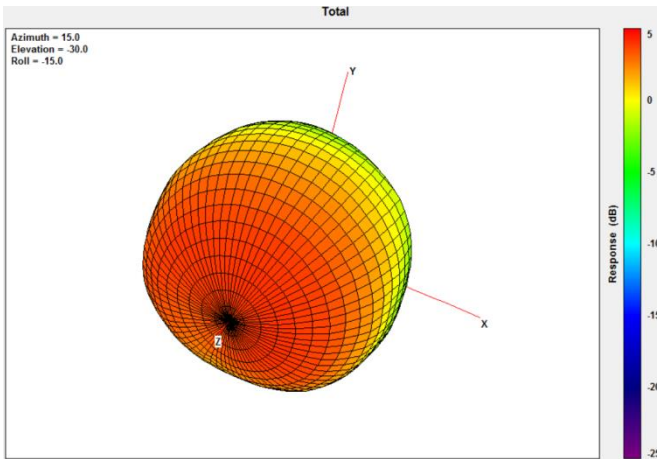

1575MHz

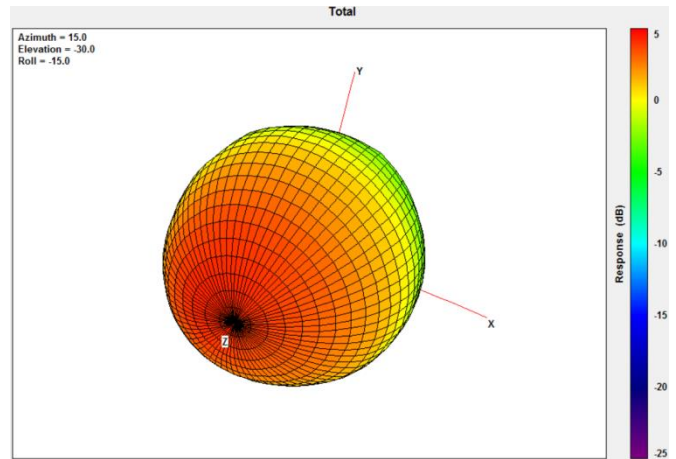

1602MHz

3.1.9.3. Axial Ratio Pattern (Passive antenna)

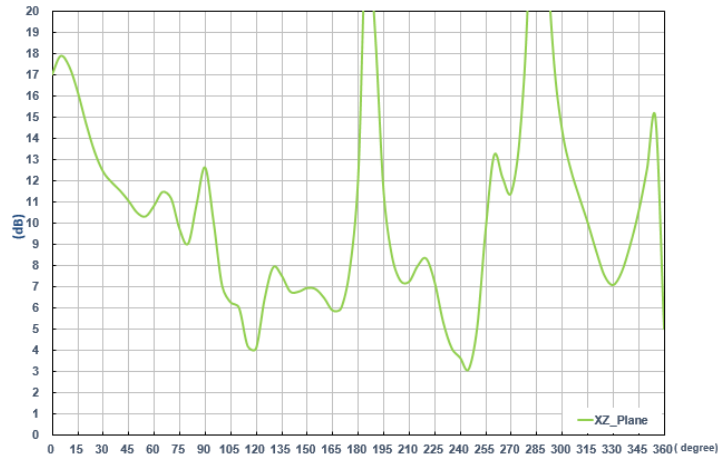

@1561MHz

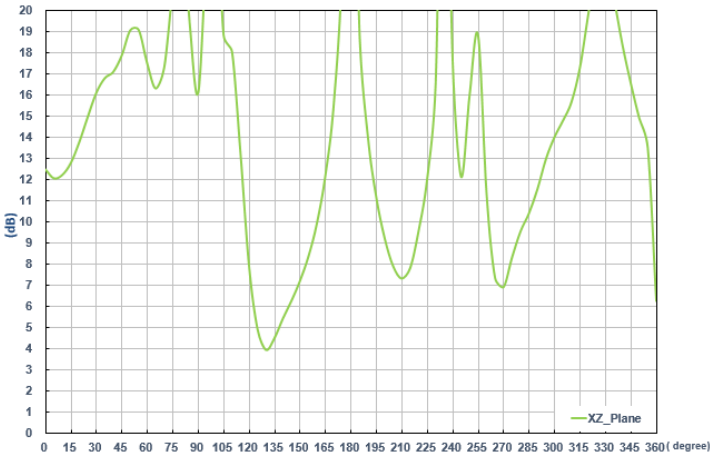

1575MHz

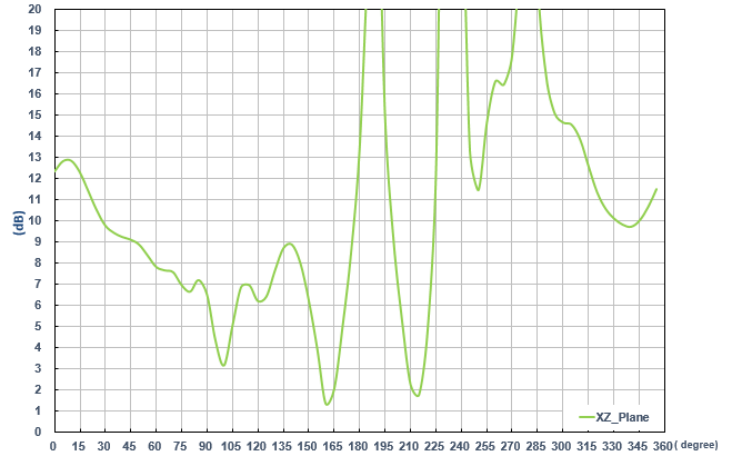

1602MHz

3.1.10. GPS-GLONASS-GALILEO-BeiDou LNA Gain and Noise Figure (Active antenna)

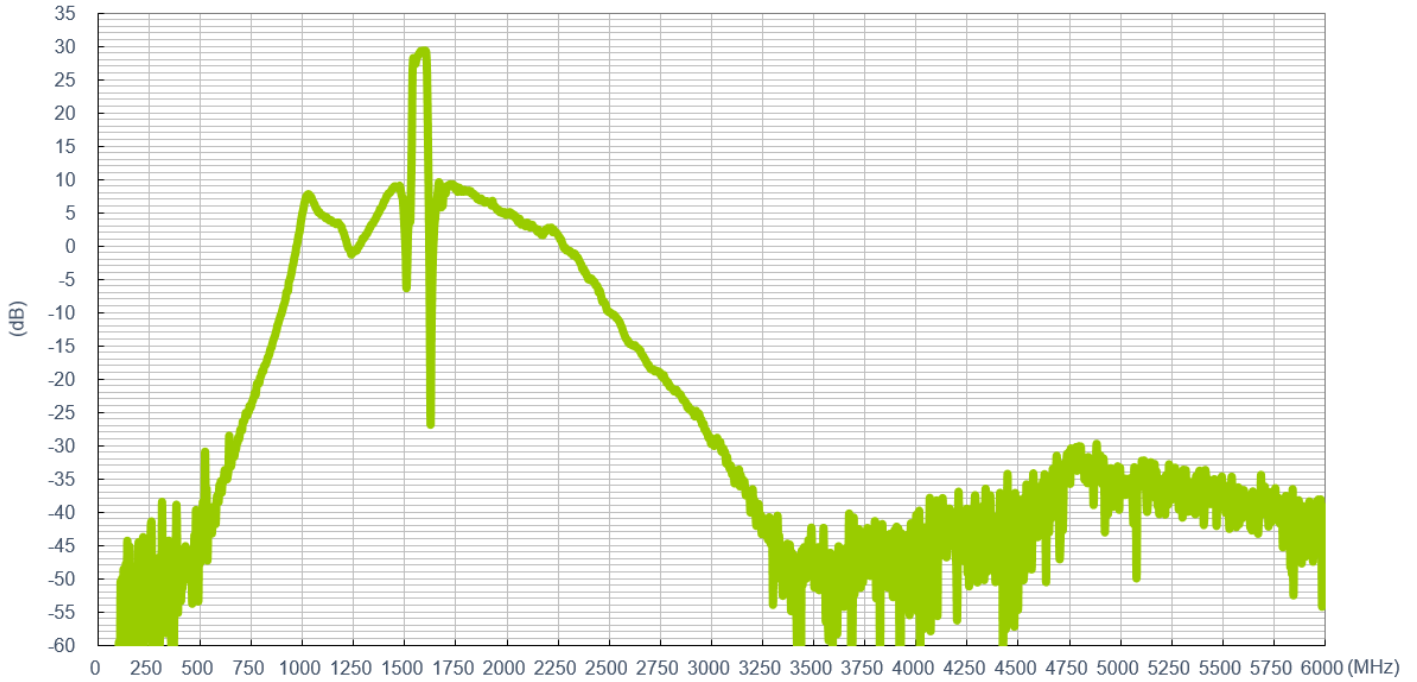

LNA Gain @3.0V

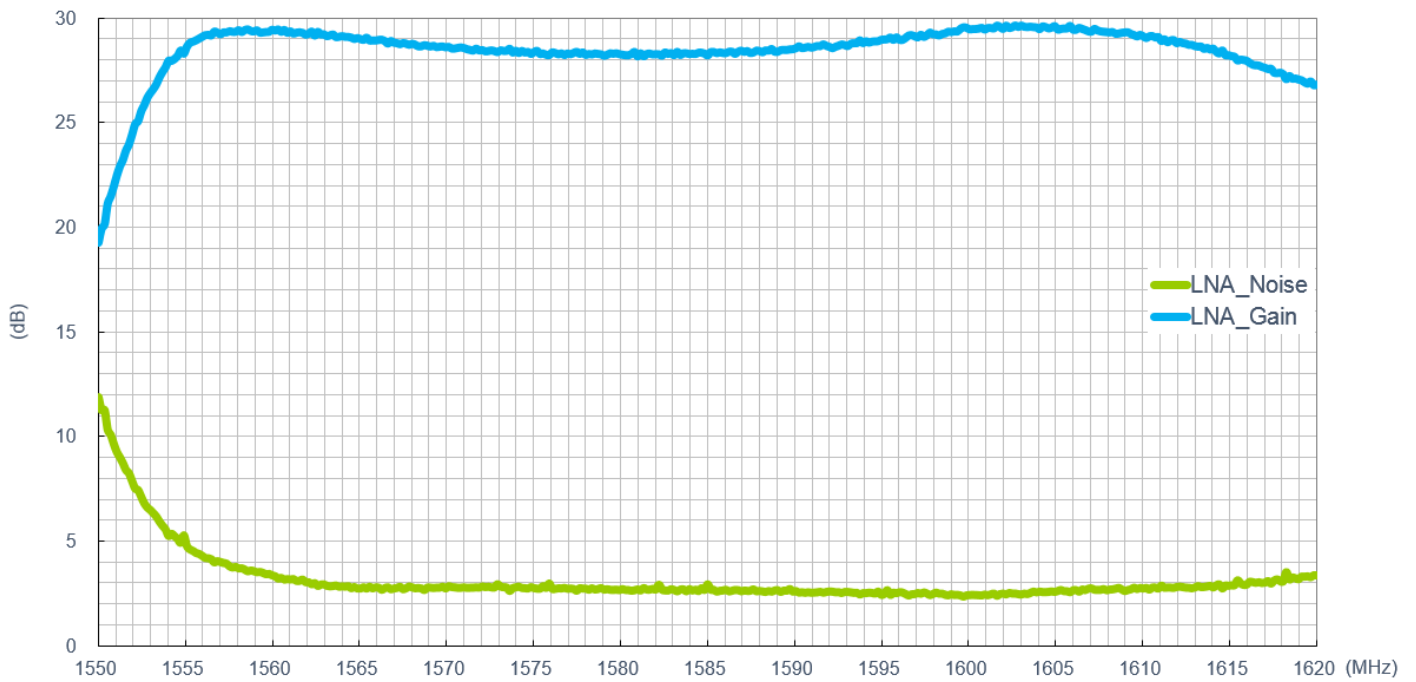

LNA Noise Figure @3.0V

3.2. LTE_MIMO Antenna

3.2.1. Test Setup

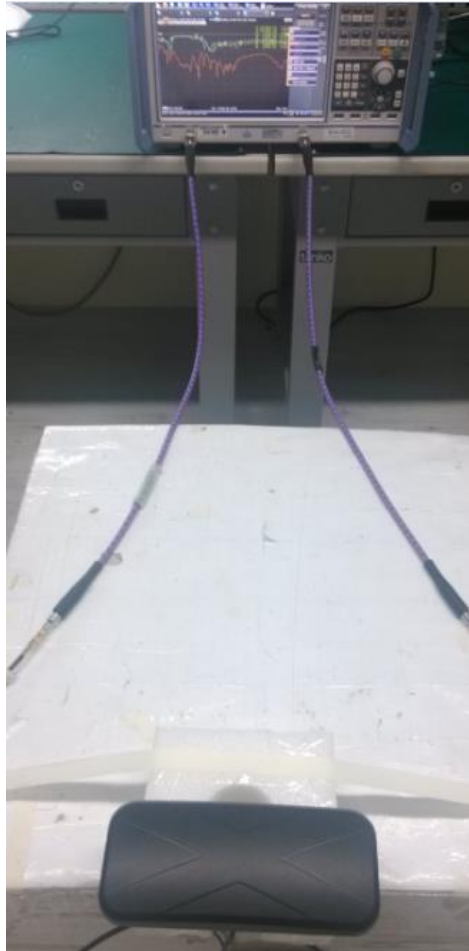

In free space

3.2.2. LTE Antenna Return Loss

Setup in free space with 3 meters cable length

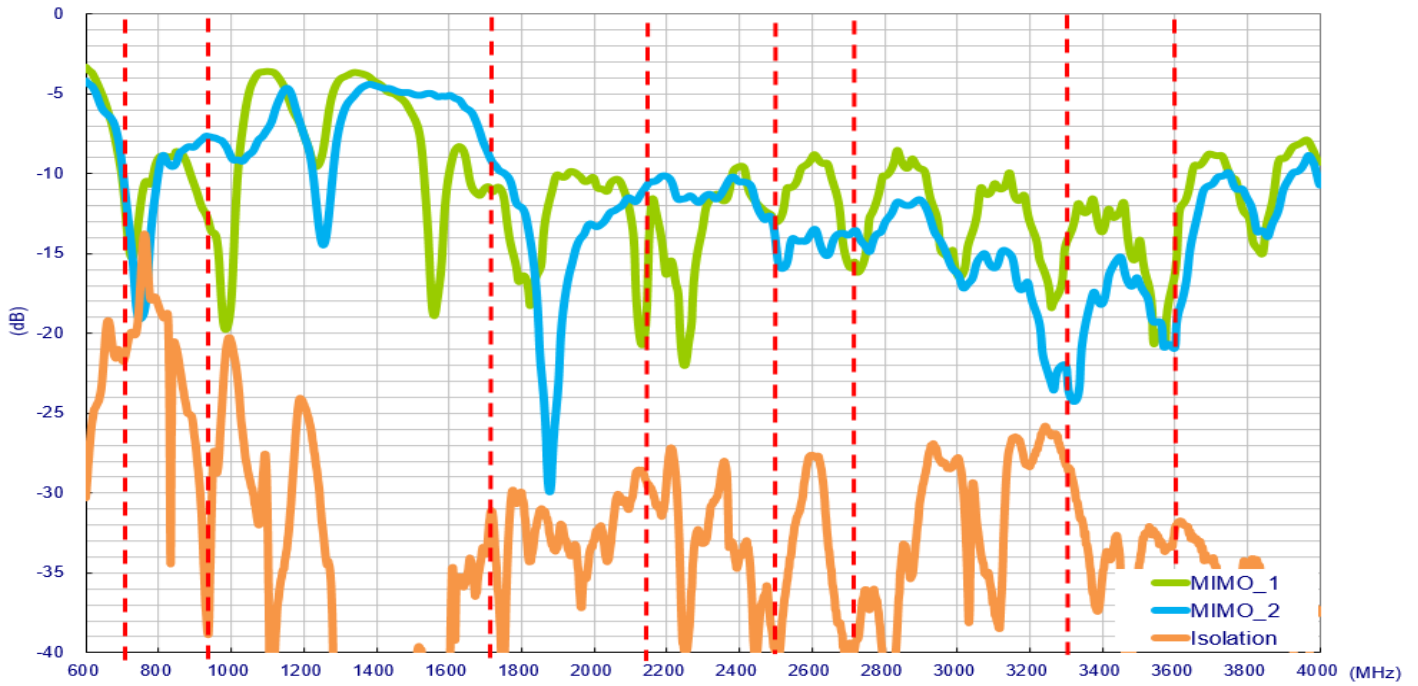

3.2.3. LTE Envelope Correlation Coefficient

Setup in free space with 3 meters cable length

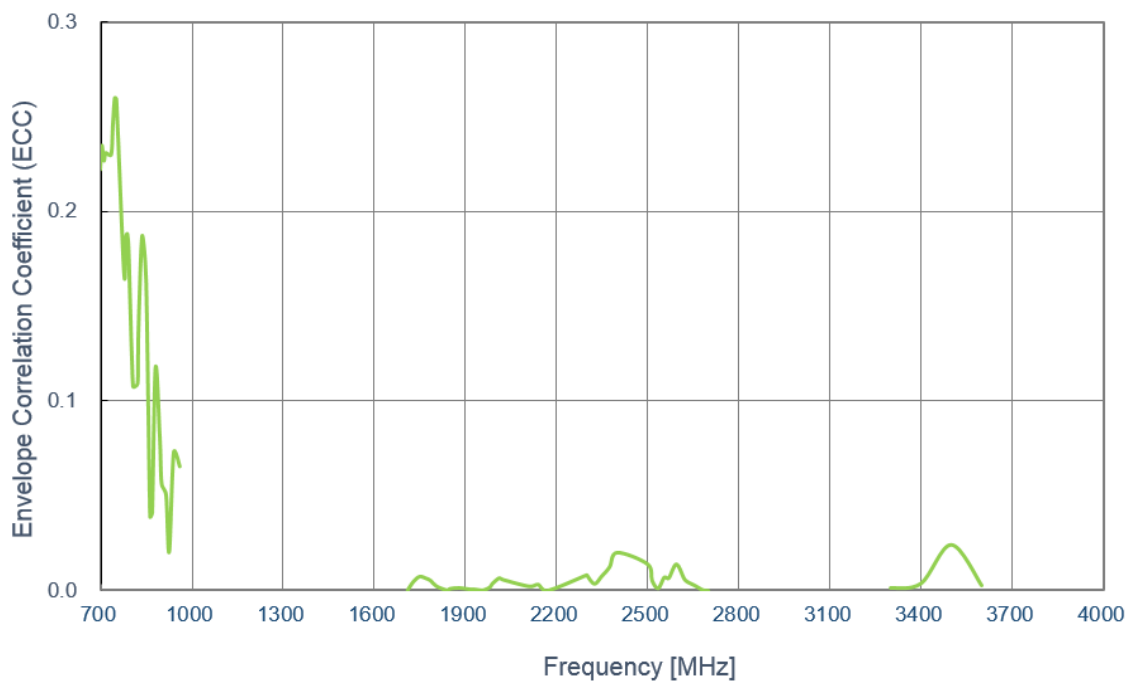

3.2.4. LTE Antenna Efficiency

Setup in free space with 3 meters cable length

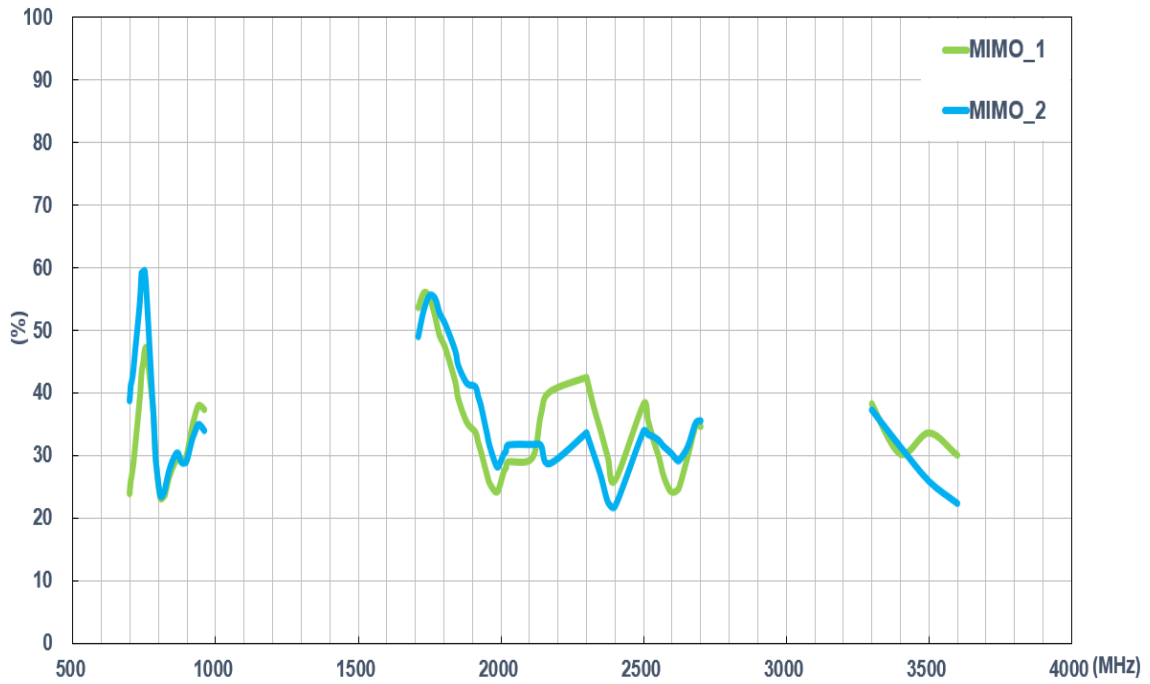

3.2.5. LTE Antenna Peak Gain

Setup in free space with 3 meters cable length

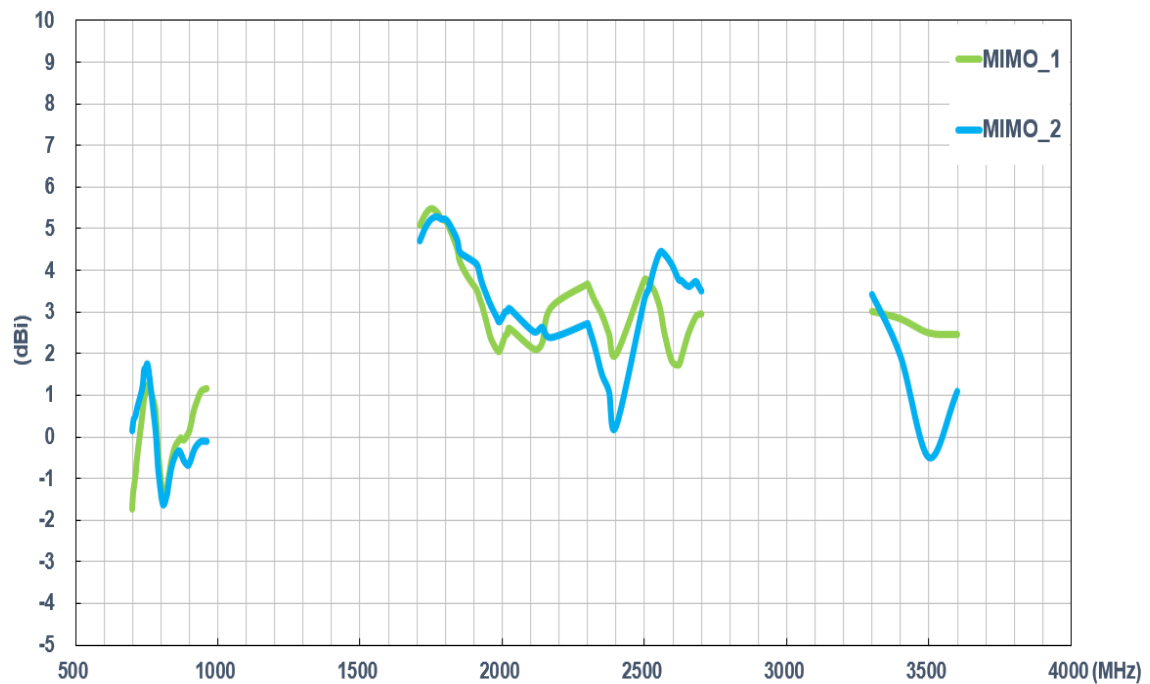

3.2.6. LTE Antenna Average Gain

Setup in free space with 3 meters cable length

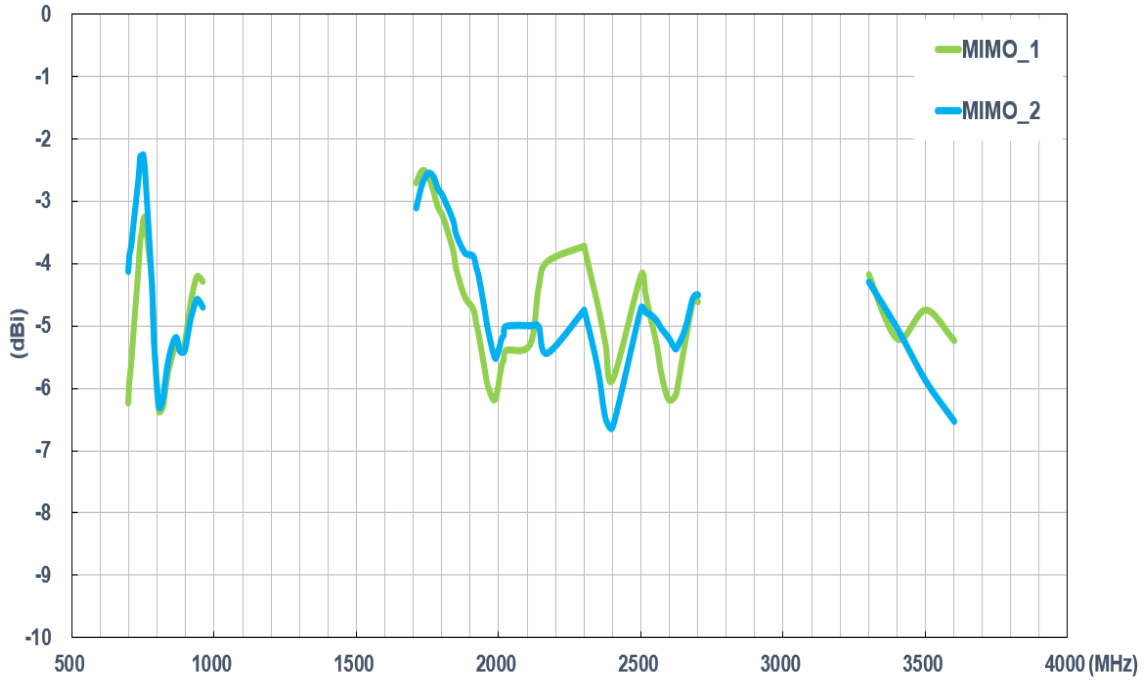

4. Wi-Fi Antenna

4.1.1. Wi-Fi Antenna Return Loss

Setup in free space with 3 meters cable length

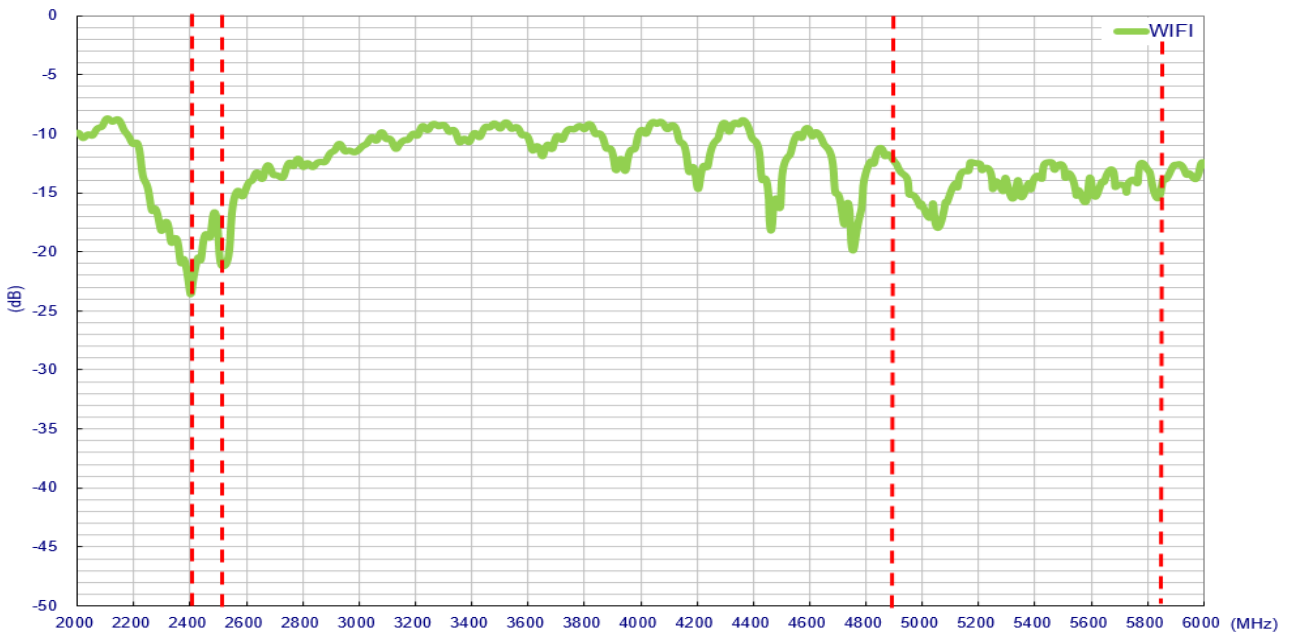

4.1.2. Wi-Fi Antenna Efficiency

Setup in free space with 3 meters cable length

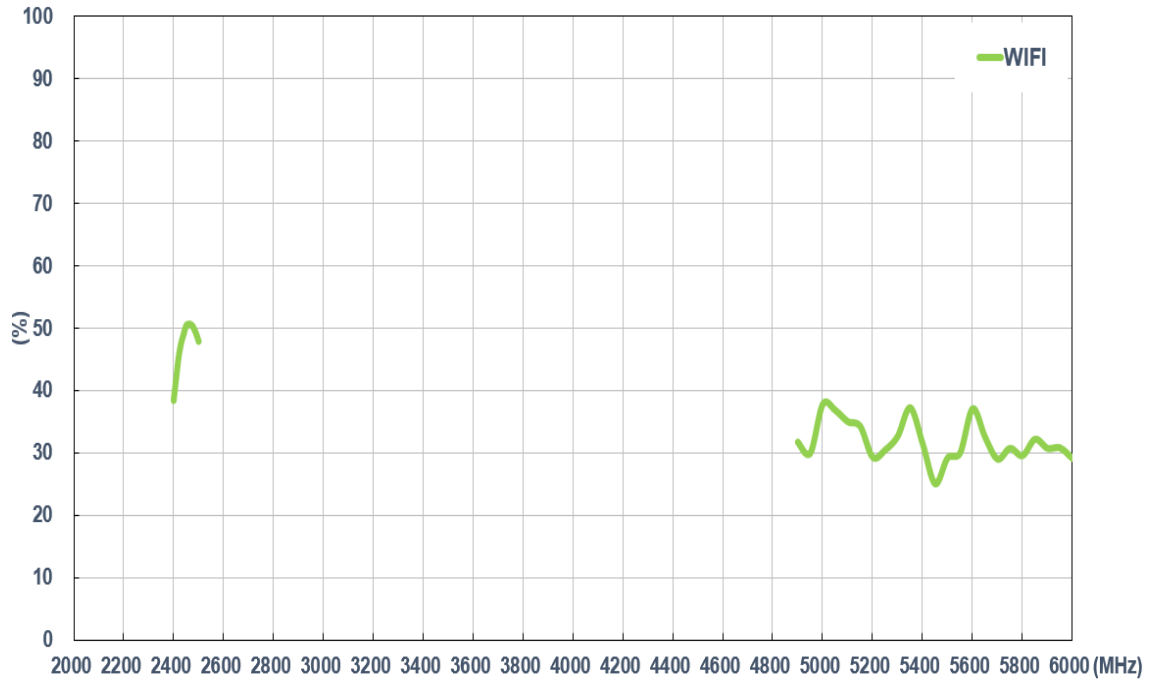

4.1.3. Wi-Fi Antenna Peak Gain

Setup in free space with 3 meters cable length

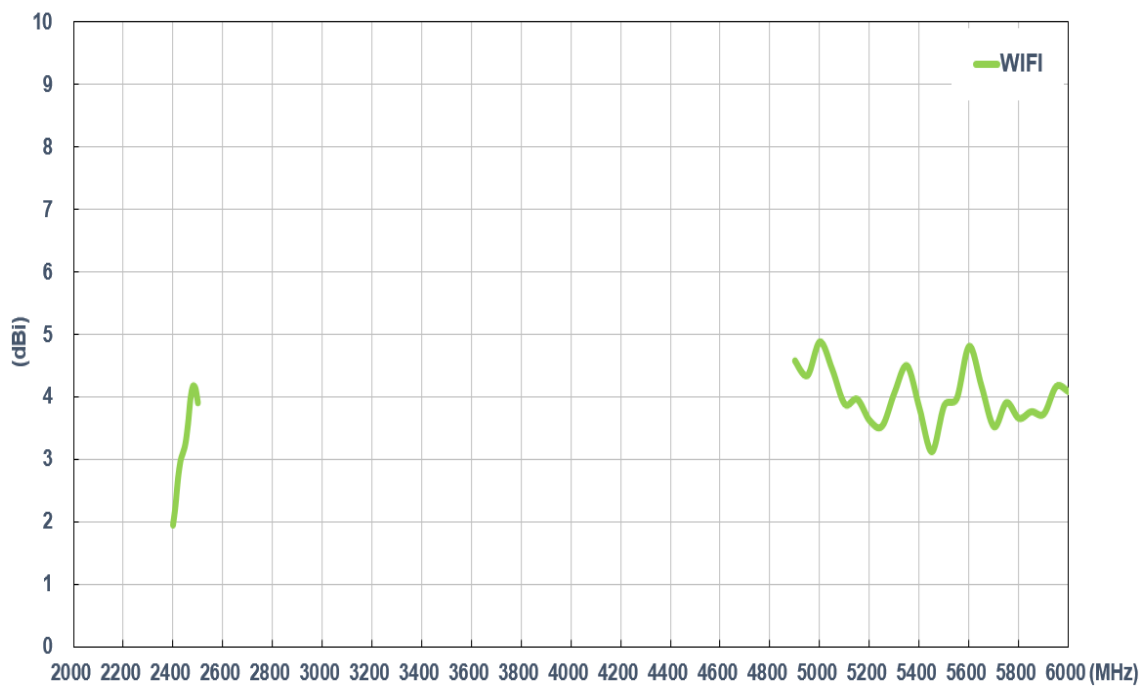

4.1.4. Wi-Fi Antenna Average Gain

Setup in free space with 3 meters cable length

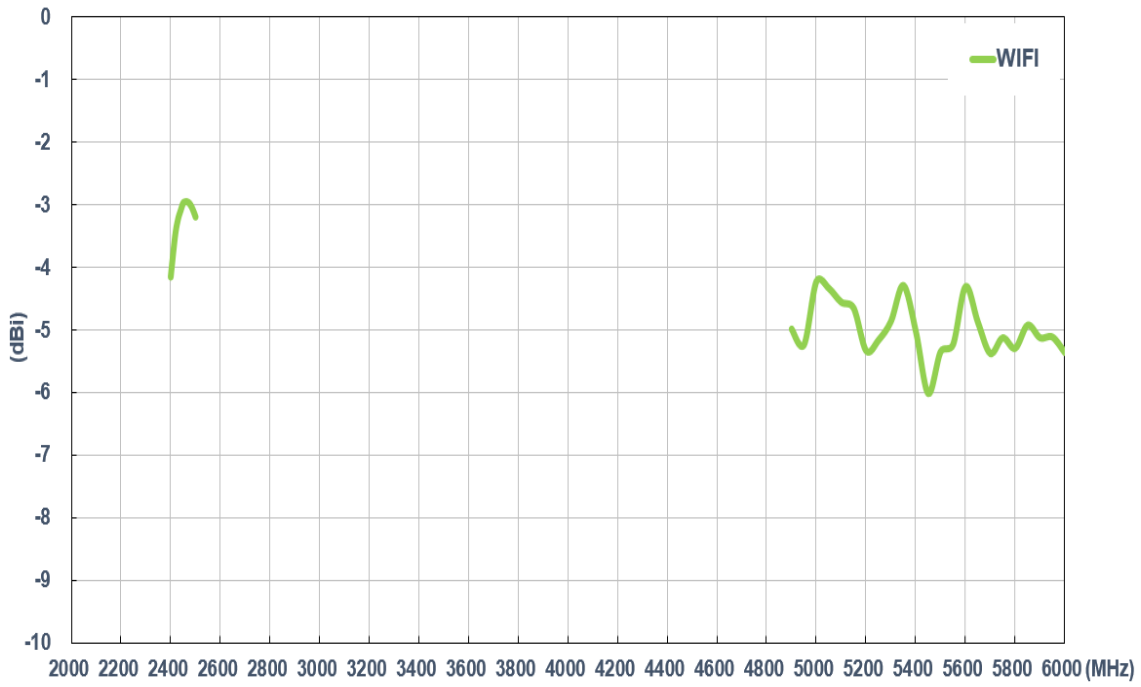

4.1.5. Test Setup for Antenna Radiation Pattern (ETS Anechoic chamber)

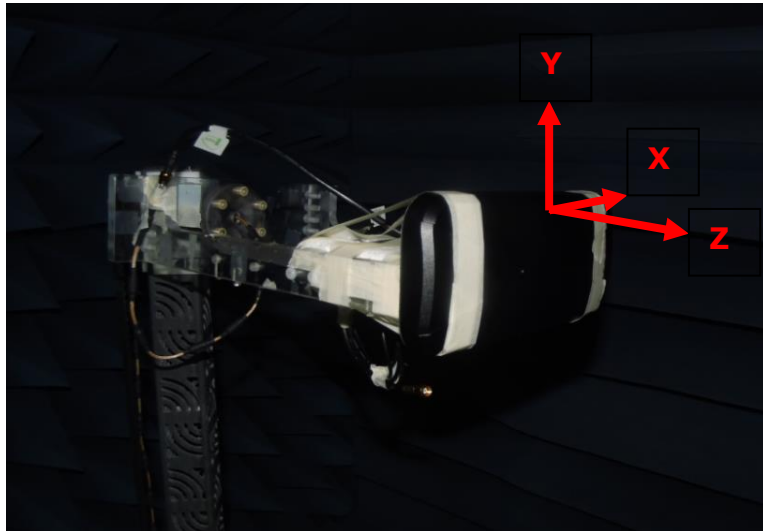

In free space

4.2. 2D Radiation Pattern (LTE_MIMO1 with 3M cable length in free space)

XY Plane

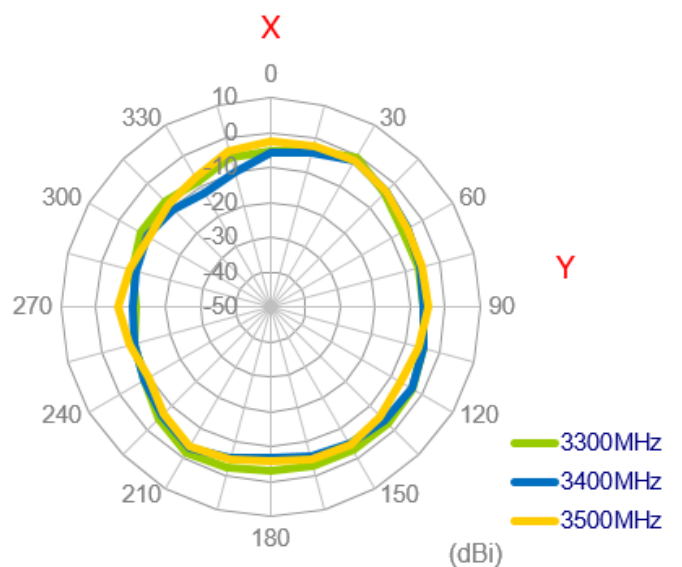
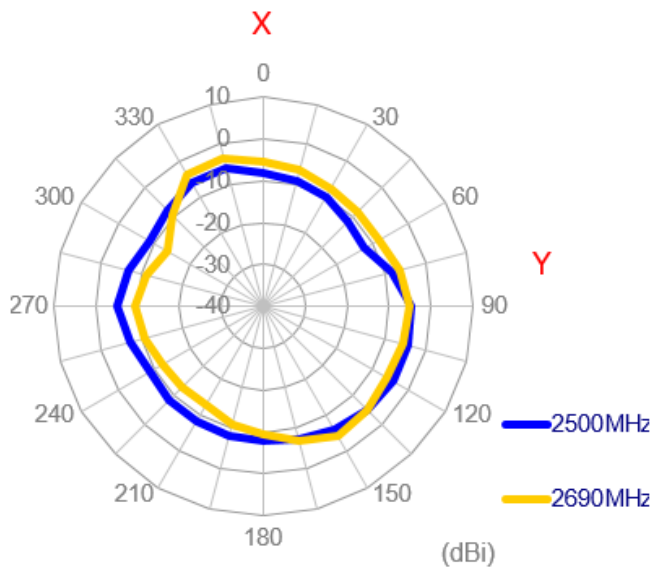
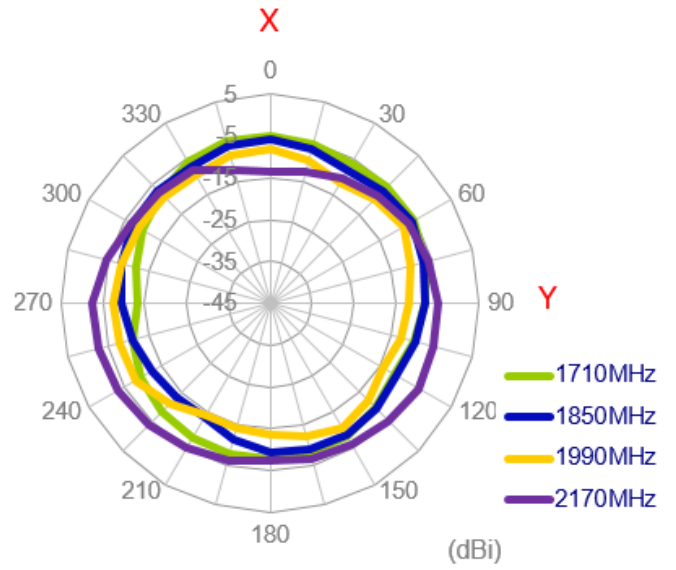
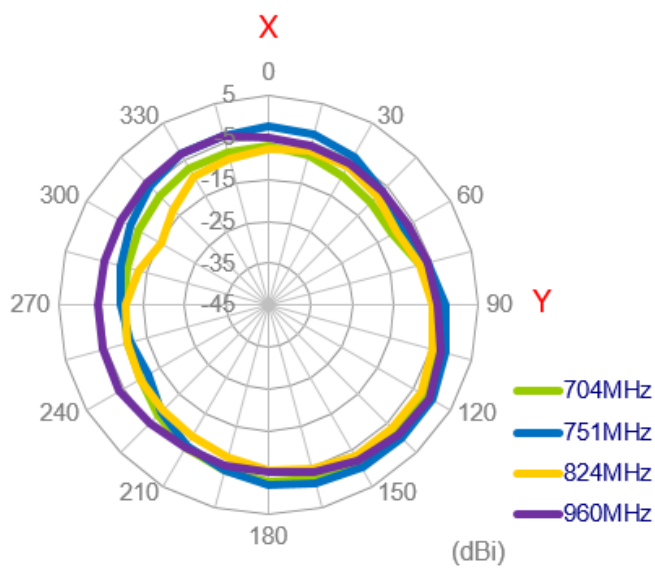

XZ Plane

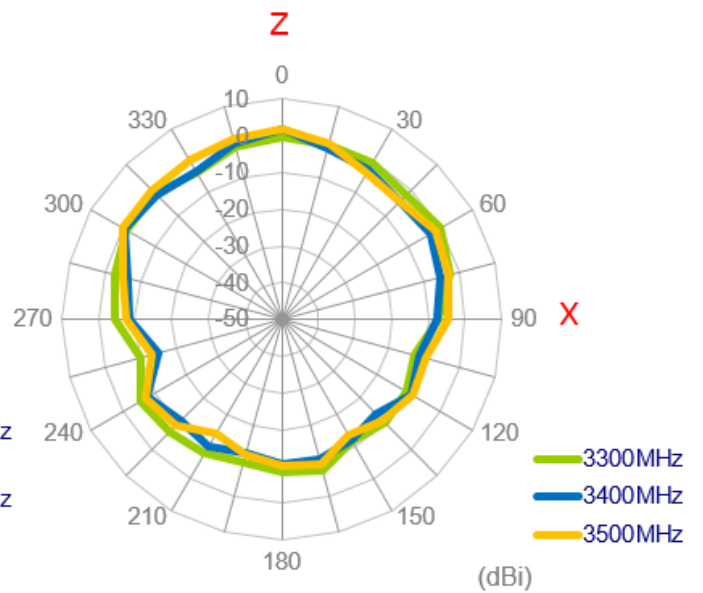
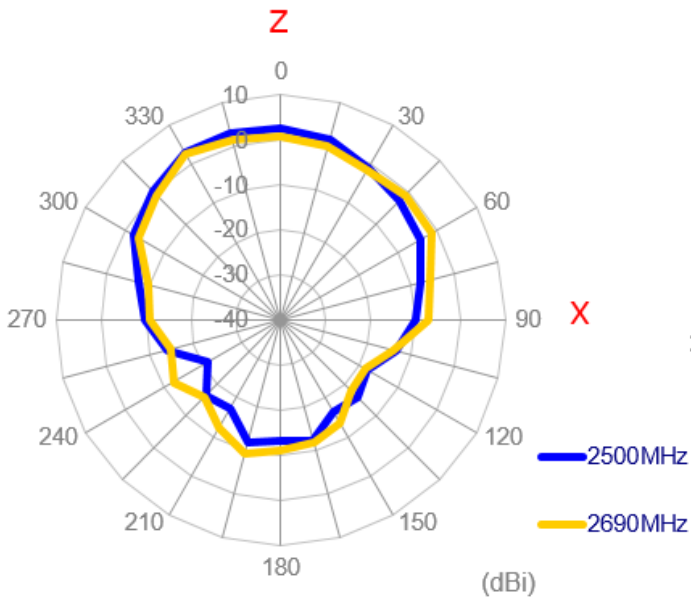
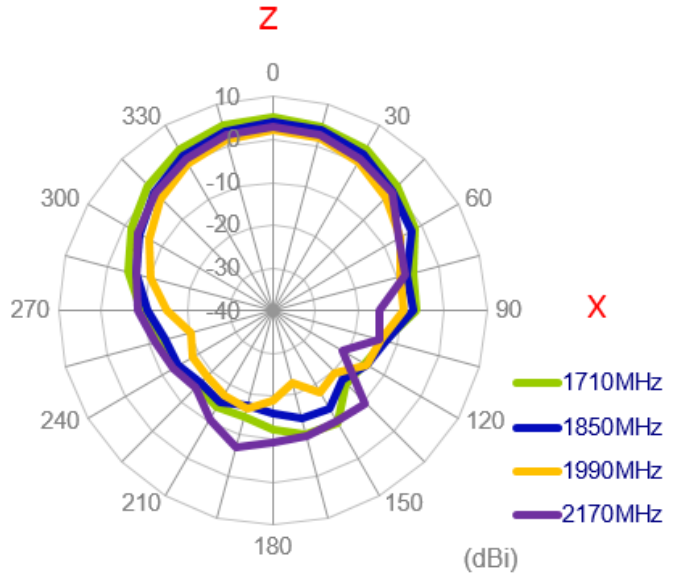
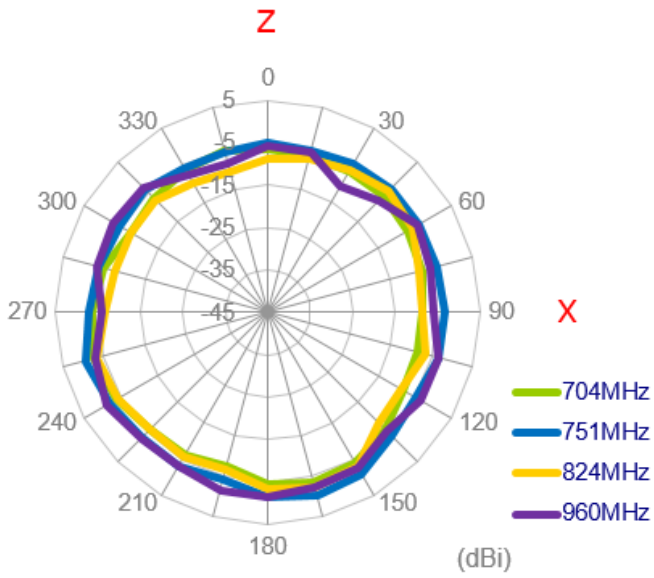

YZ Plane

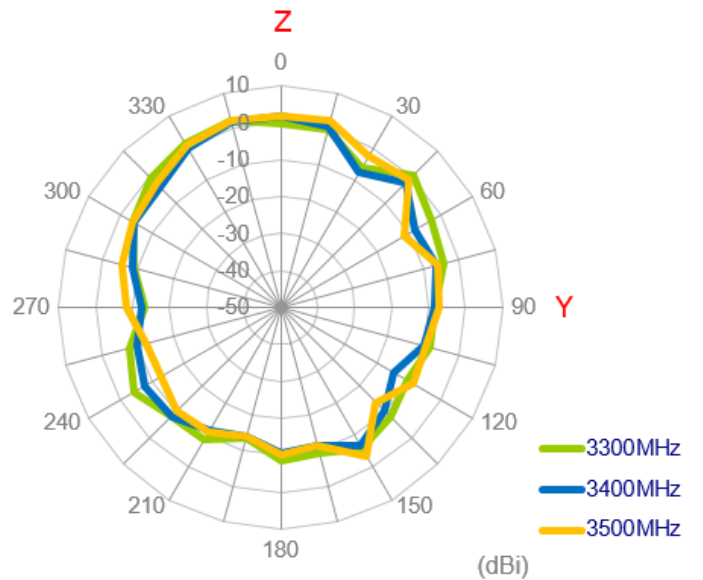
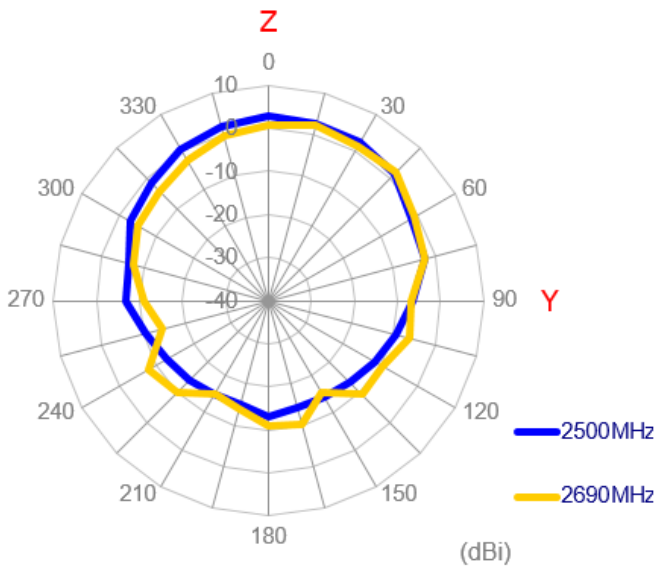
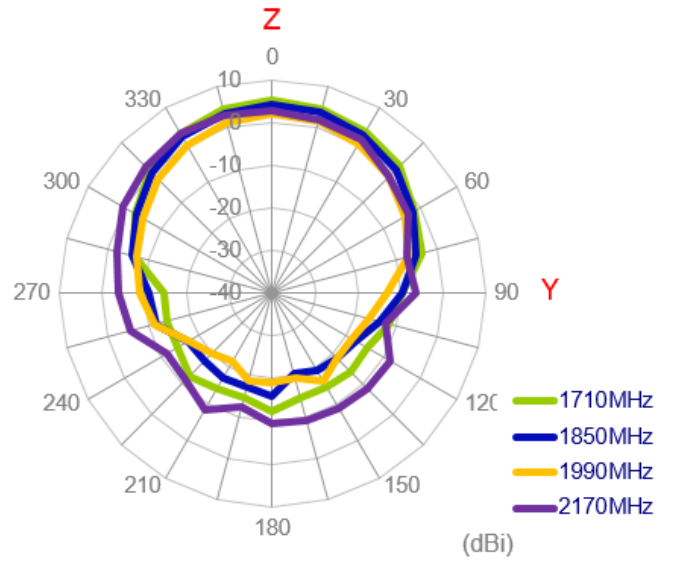
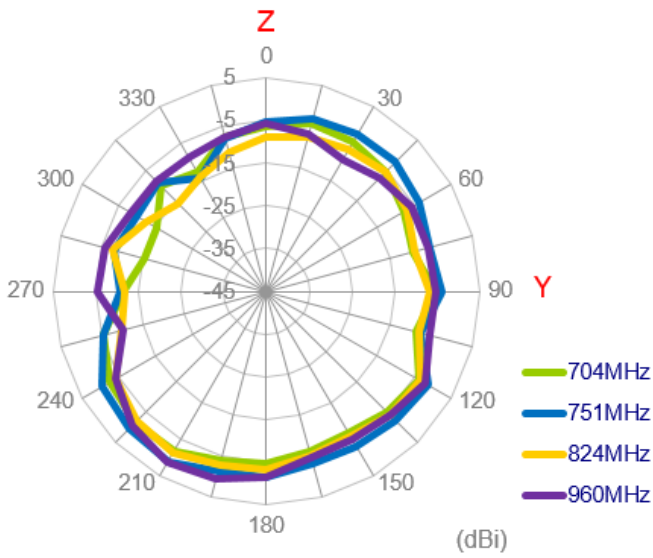

4.2.1. 3D Radiation Pattern (LTE_MIMO1 with 3M cable length in free space)

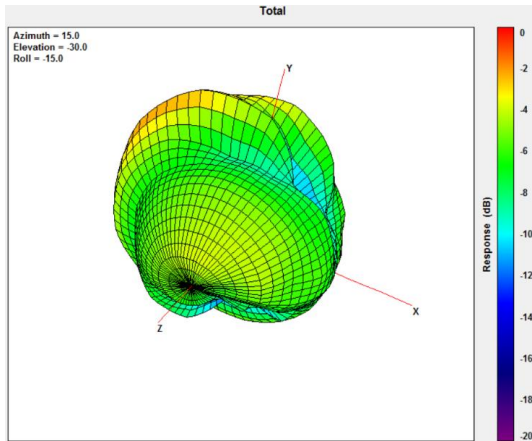

@704MHz

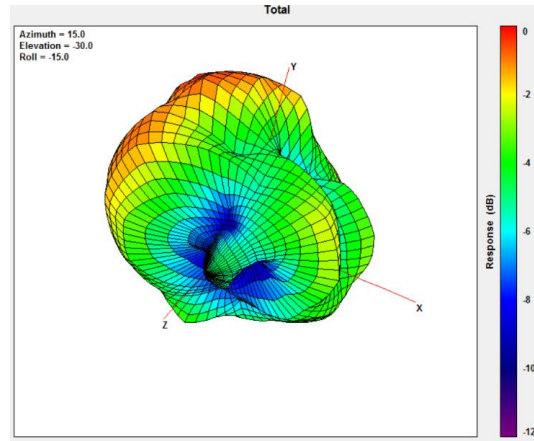

@960MHz

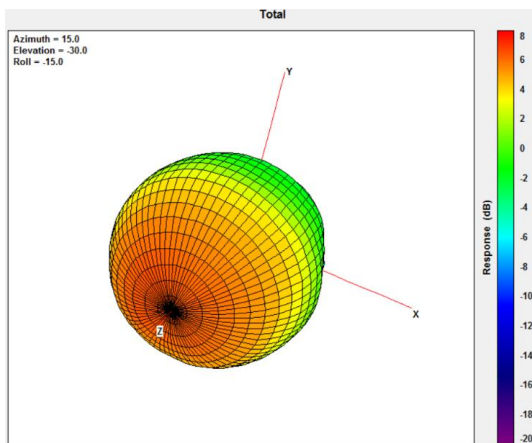

@1710MHz

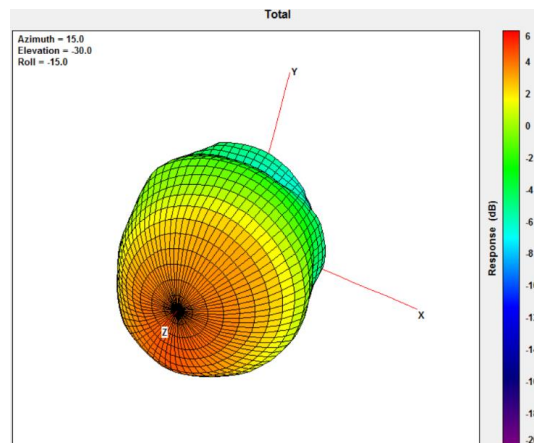

@2170MHz

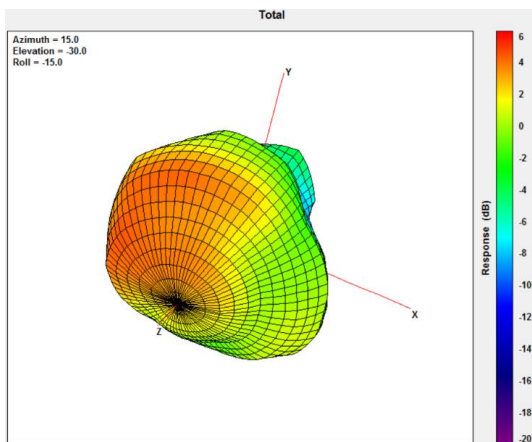

@2690MHz

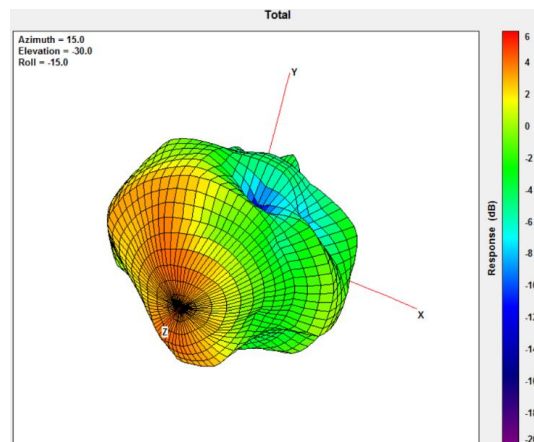

3500MHZ

4.2.2. 2D Radiation Pattern (LTE_MIMO2 with 3M cable length in free space)

XY Plane

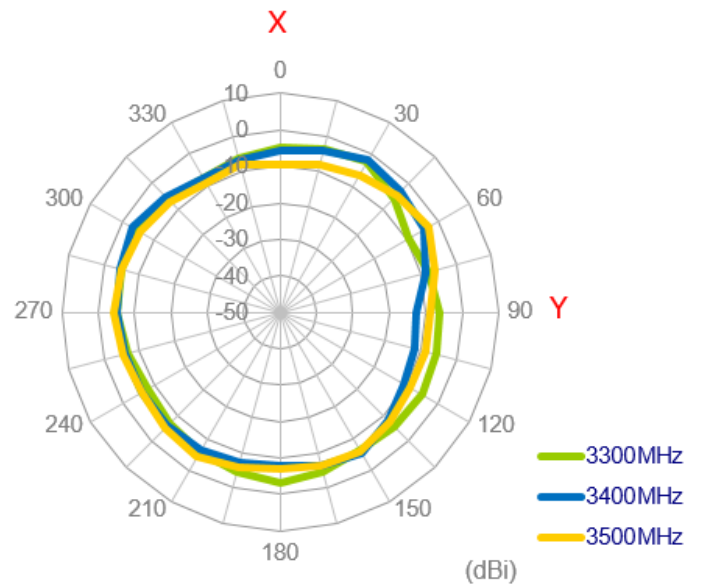
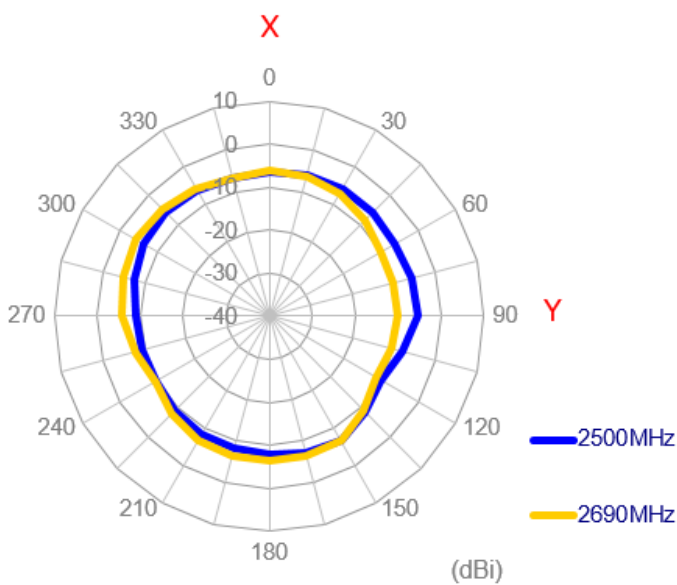
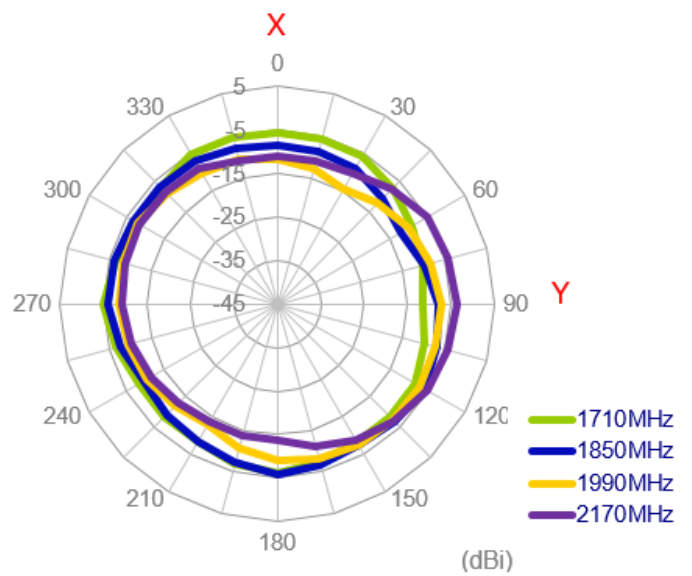
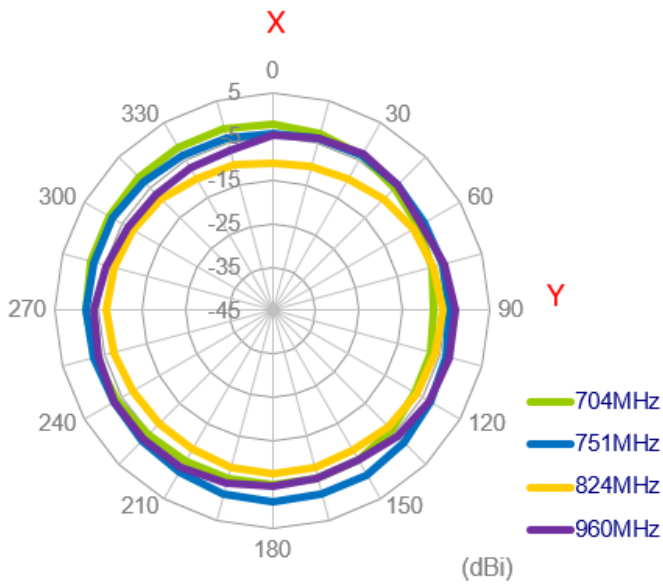

XZ Plane

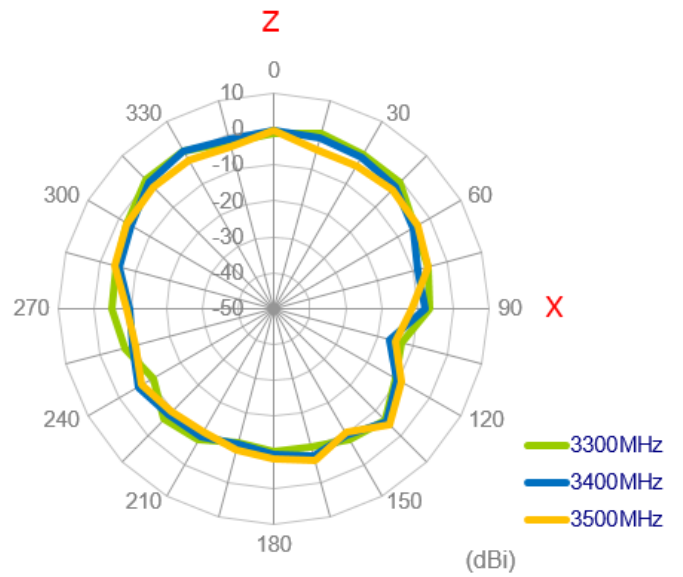
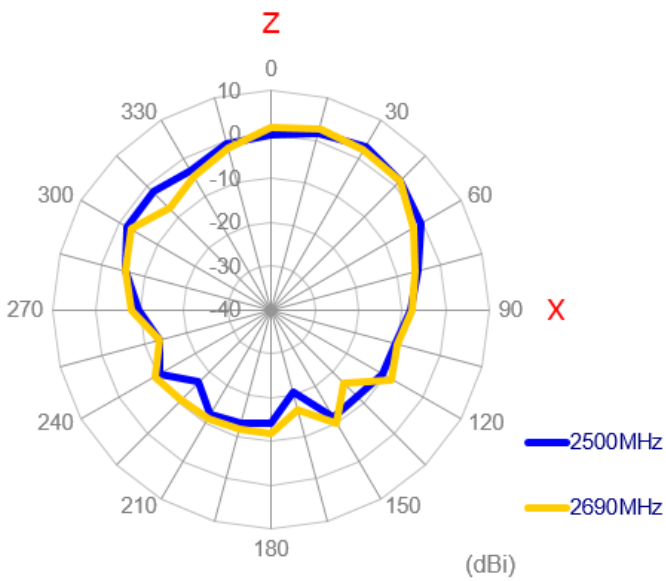
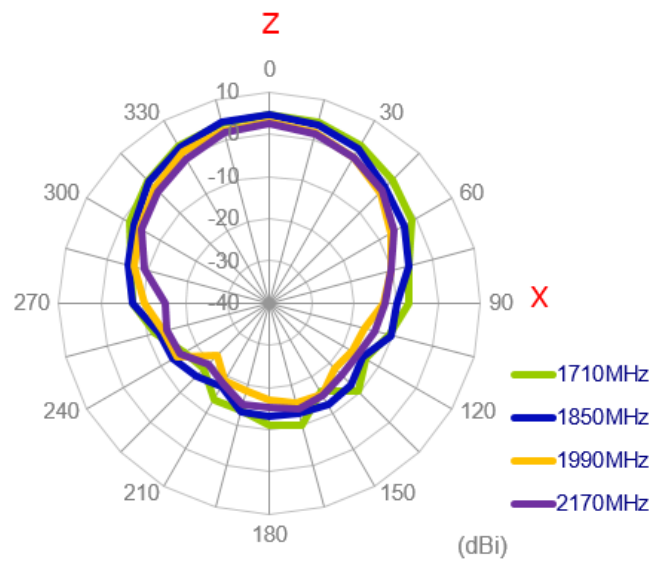
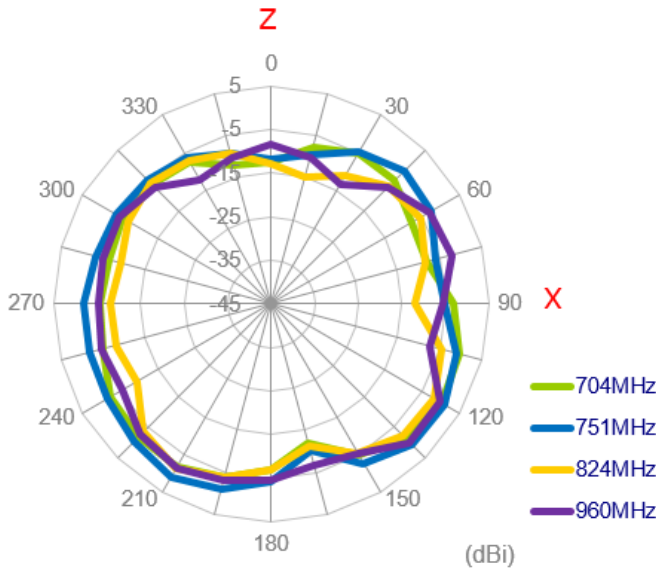

YZ Plane

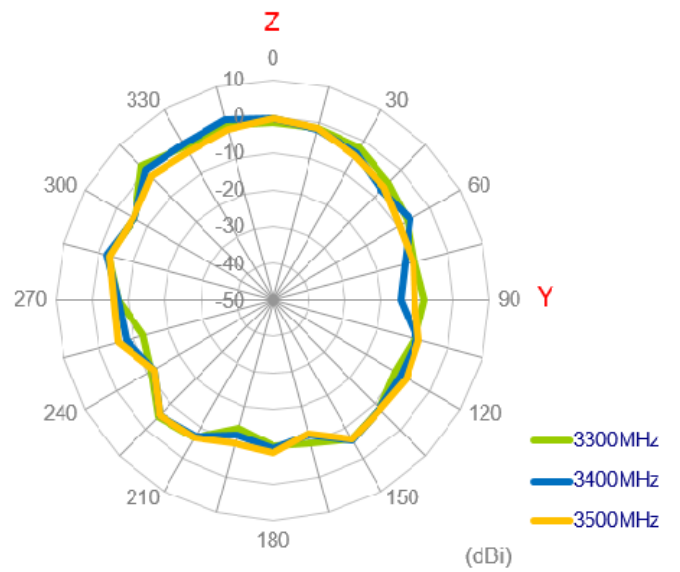
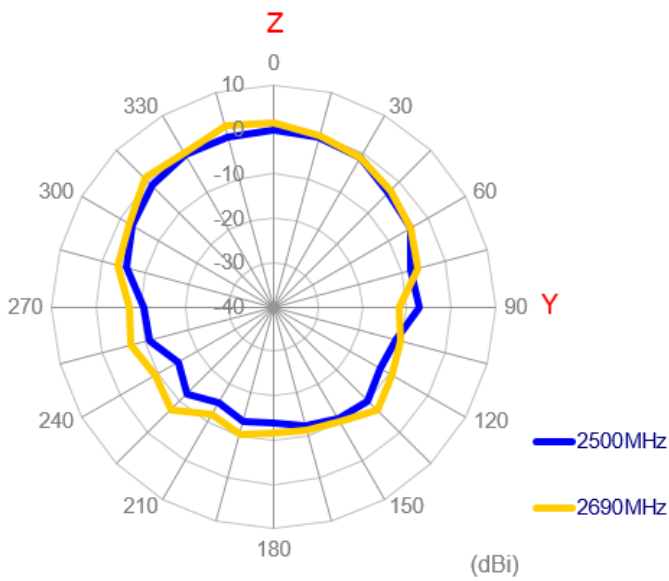
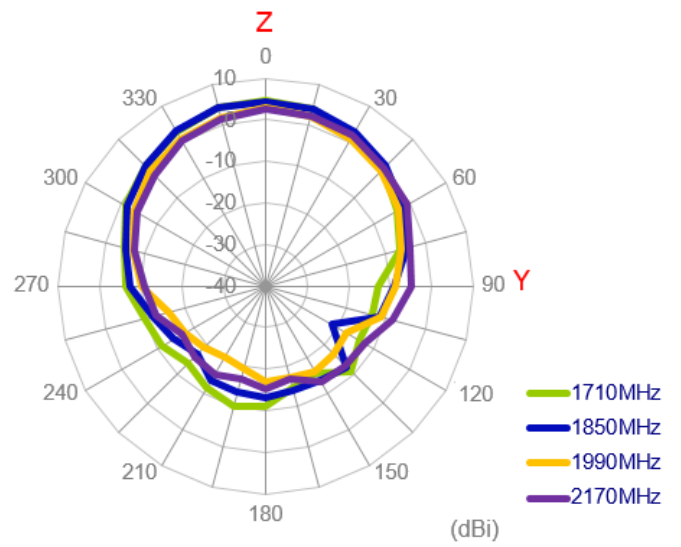
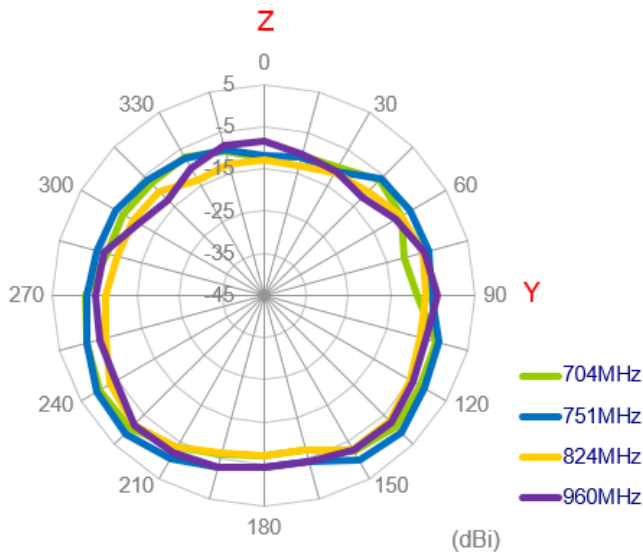

4.2.3. 2D Radiation Pattern (LTE_MIMO2 with 3M cable length in free space)

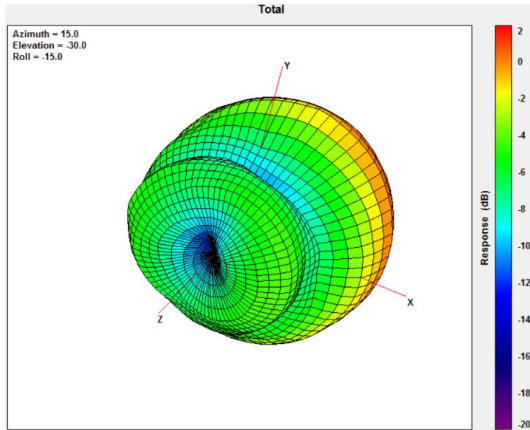

704MHz

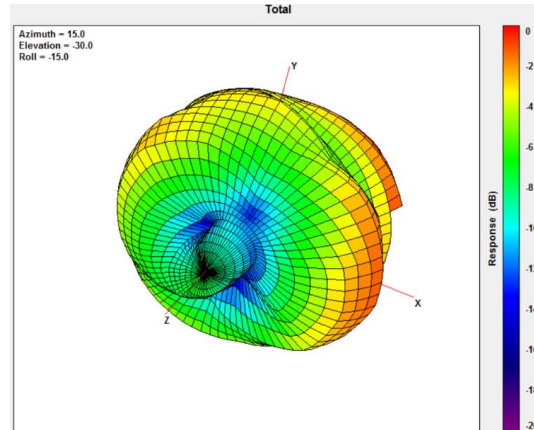

960MHz

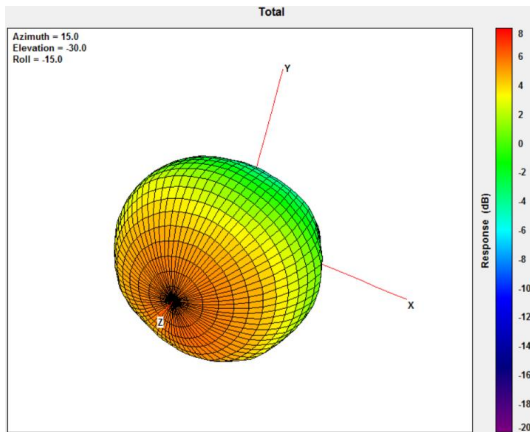

1710MHz

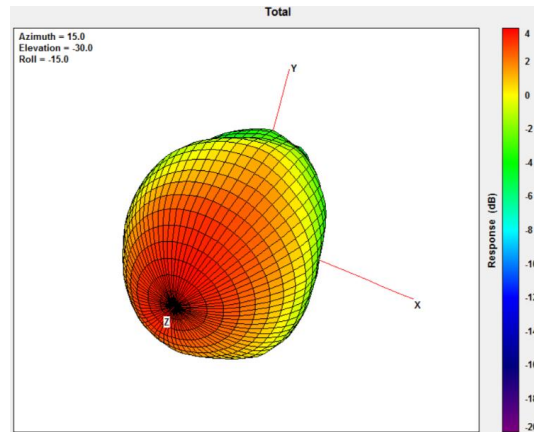

2170MHz

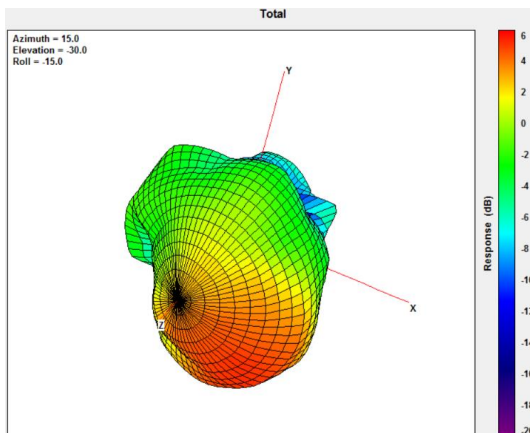

2690MHz

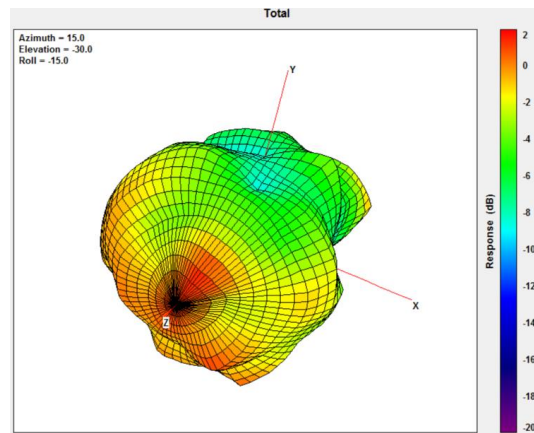

3500MHz

4.2.4. 2D Radiation Pattern (Wi-Fi with 3M cable length in free space)

XY Plane

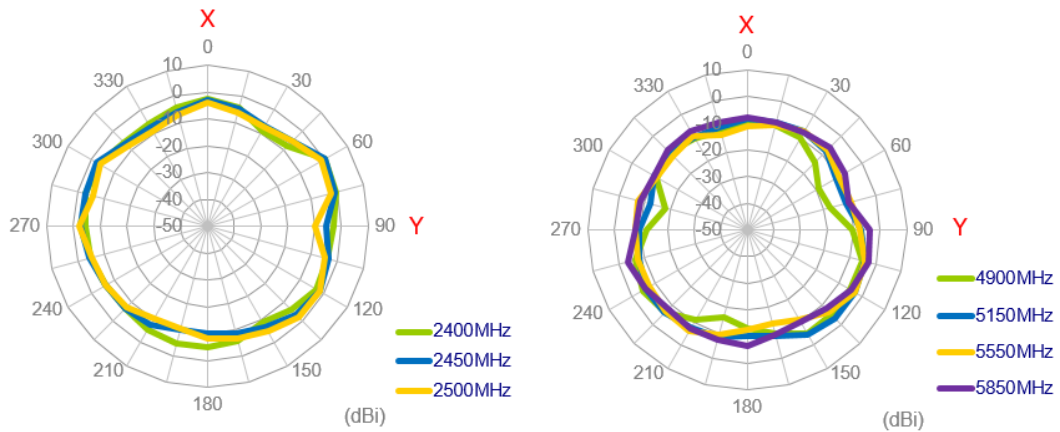

XZ Plane

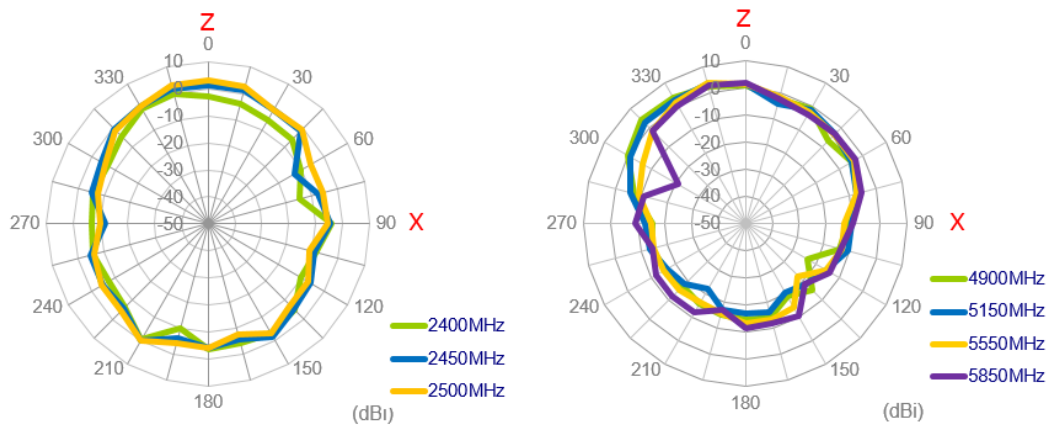

YZ Plane

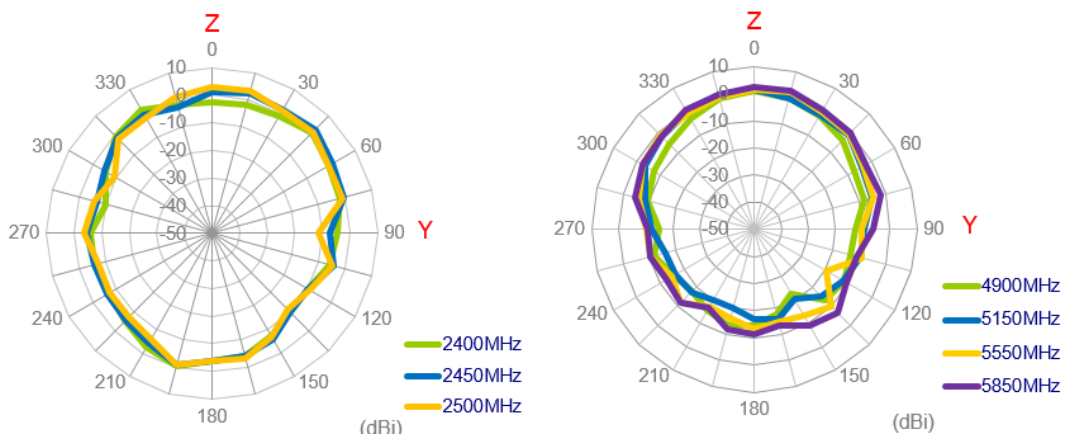

4.2.5. 2D Radiation Pattern (Wi-Fi with 3M cable length in free space)

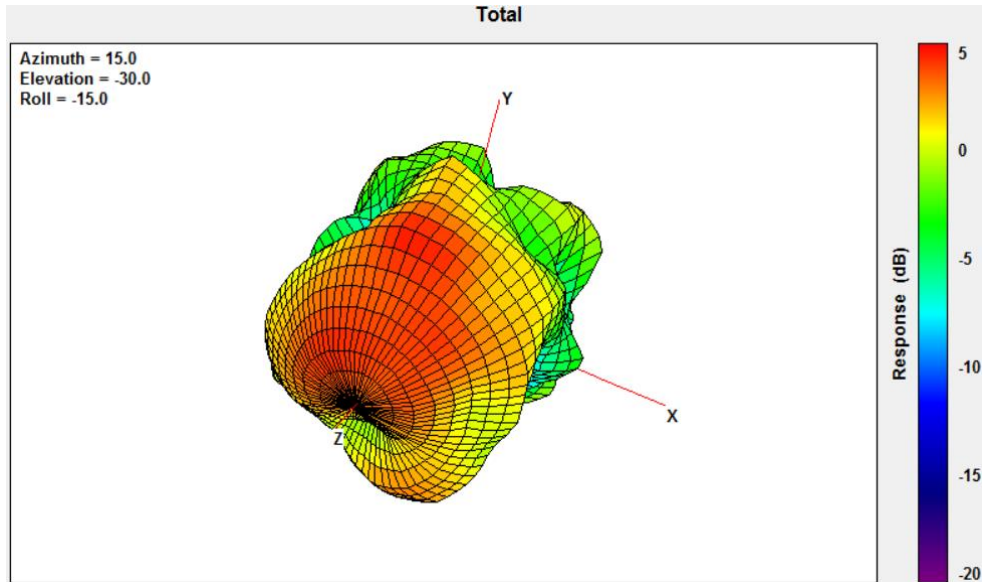

2450MHz

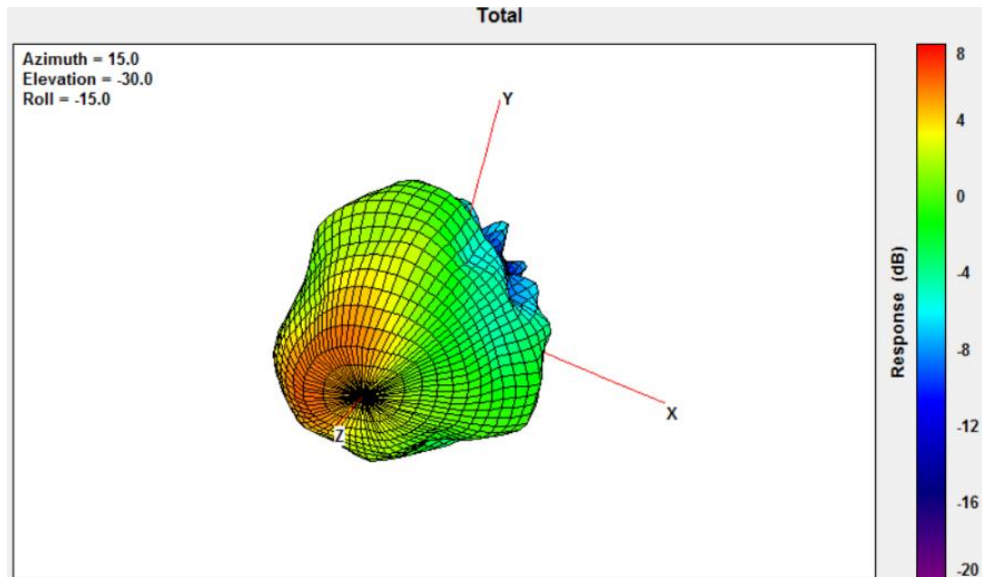

5550MHz

5. Mechanical Drawing (Unit: mm)

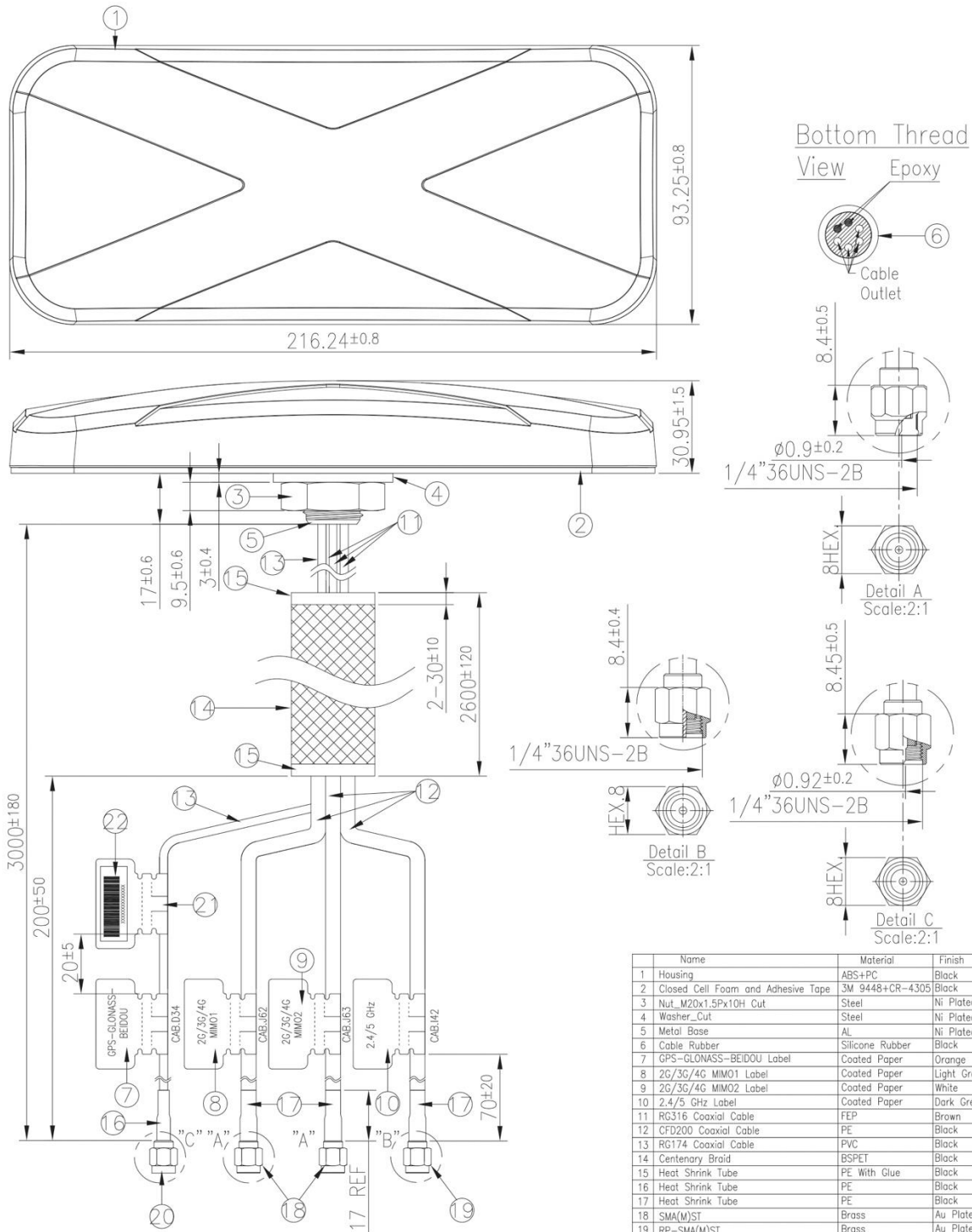

Name	Material	Finish	QTY
1 Housing	ABS+PC	Black	1
2 Closed Cell Foam and Adhesive Tape	3M 9448+CR-4305	Black	1
3 Nut_M20x1.5Px10H Cut	Steel	Ni Plated	1
4 Washer_Cut	Steel	Ni Plated	1
5 Metal Base	AL	Ni Plated	1
6 Cable Rubber	Silicone Rubber	Black	1
7 GPS-GLONASS-BEIDOU Label	Coated Paper	Orange	1
8 2G/3G/4G MIMO1 Label	Coated Paper	Light Gray	1
9 2G/3G/4G MIMO2 Label	Coated Paper	White	1
10 2.4/5 GHz Label	Coated Paper	Dark Green	1
11 RG316 Coaxial Cable	FEP	Brown	3
12 CFD200 Coaxial Cable	PE	Black	3
13 RG174 Coaxial Cable	PVC	Black	2
14 Centenary Braid	BSPET	Black	1
15 Heat Shrink Tube	PE With Glue	Black	2
16 Heat Shrink Tube	PE	Black	1
17 Heat Shrink Tube	PE	Black	3
18 SMA(M)ST	Brass	Au Plated	2
19 RP-SMA(M)ST	Brass	Au Plated	1
20 SMA(M)ST	Brass	Au Plated	1
21 Empty Label	PET	White	1
22 Barcode Label	PET	White	1

6. Installation

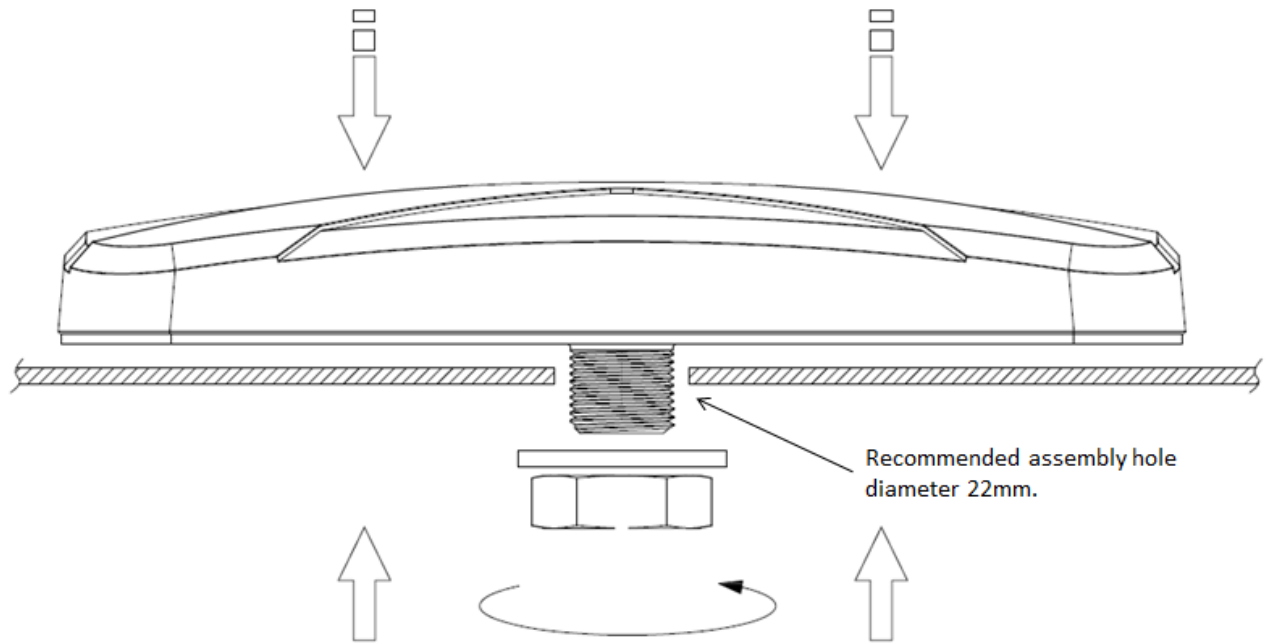

Recommended torque for mounting is 29,4 N.m or 300 kgf.cm
Maximum torque for mounting is 39,2 N.m or 400 kgf.cm

7. Packaging

MA460.K.LBIC.002

Packaging Specifications

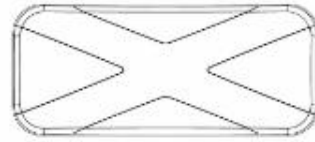

2 pc MA460.K.LBIC.002 per carton
 Carton Dimensions - 590*300*140mm
 Total Weight - 2.4Kg

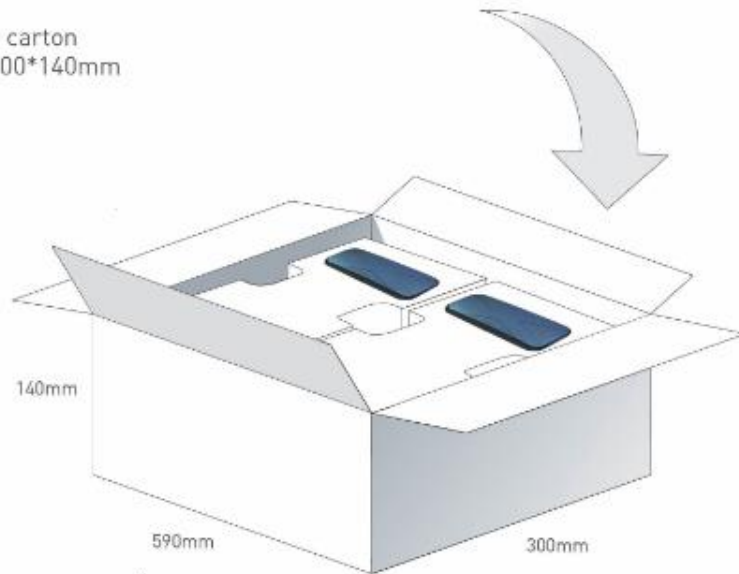

Pallet Dimensions 1220*1020*1410mm
 54 Cartons per pallet
 9 Cartons per layer
 6 Layers

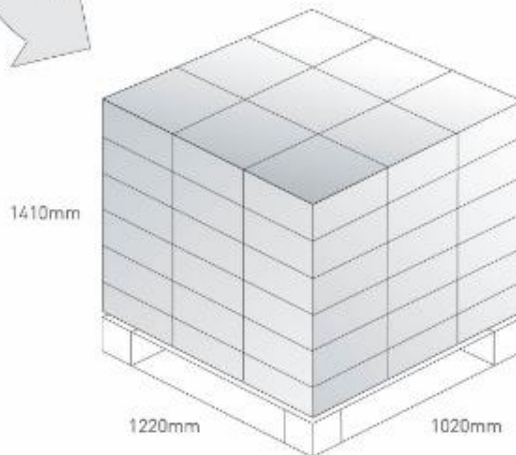

8. Application Note

The MA460 antenna performance with different cable lengths is shown below.

8.1. In free space (LTE MIMO Antenna)

8.1.1. Return Loss (LTE MIMO_1)

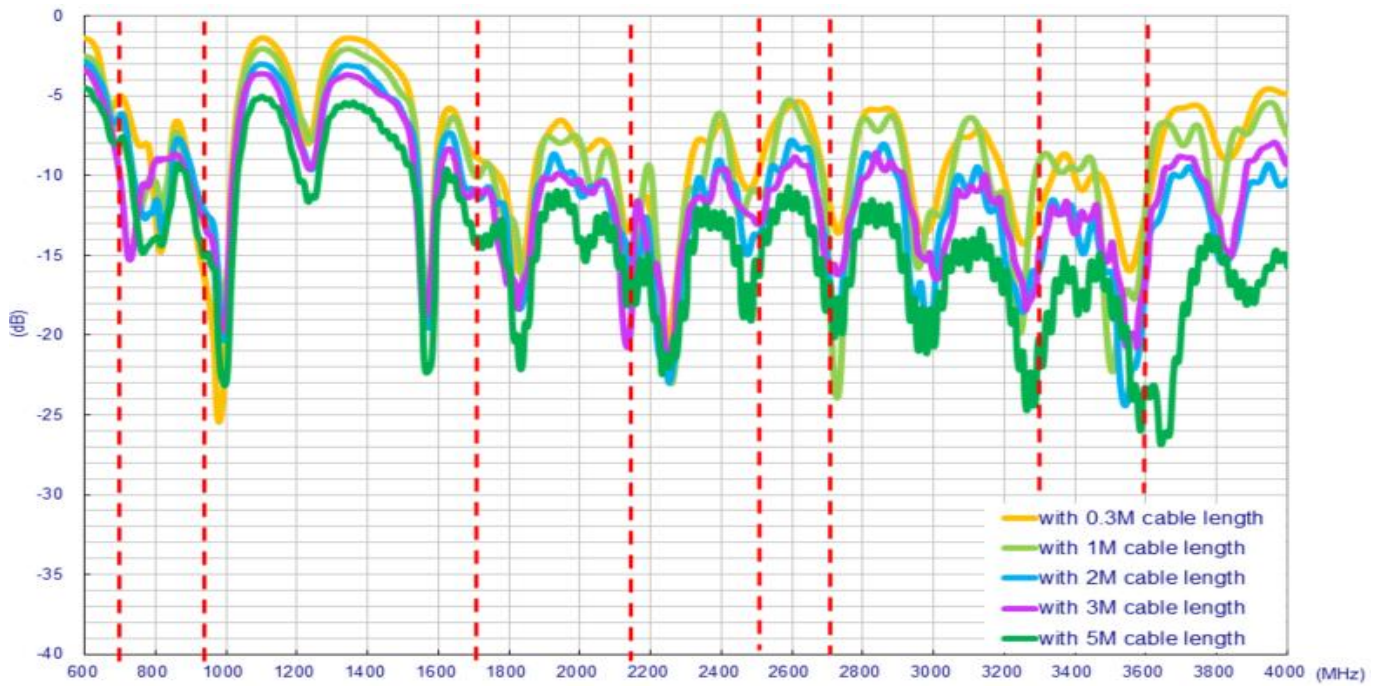

8.1.2. Return Loss (LTE MIMO_2)

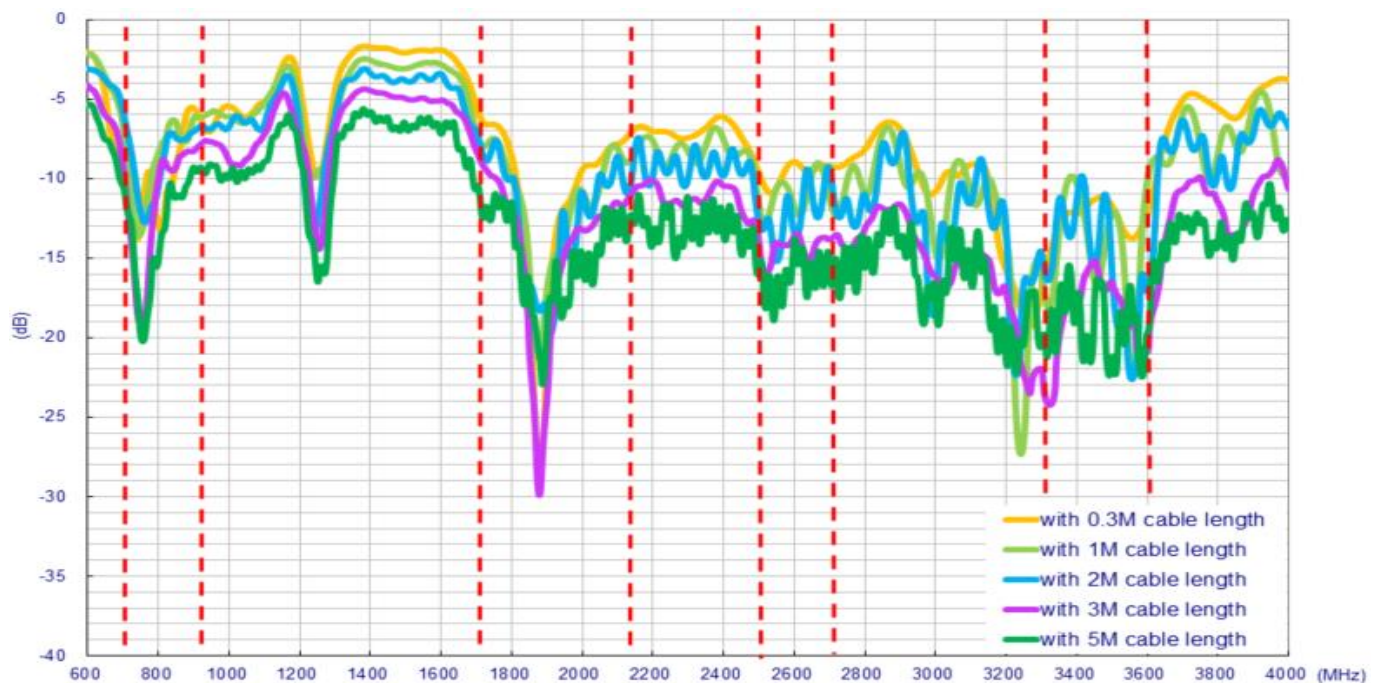

8.1.3. Isolation Loss

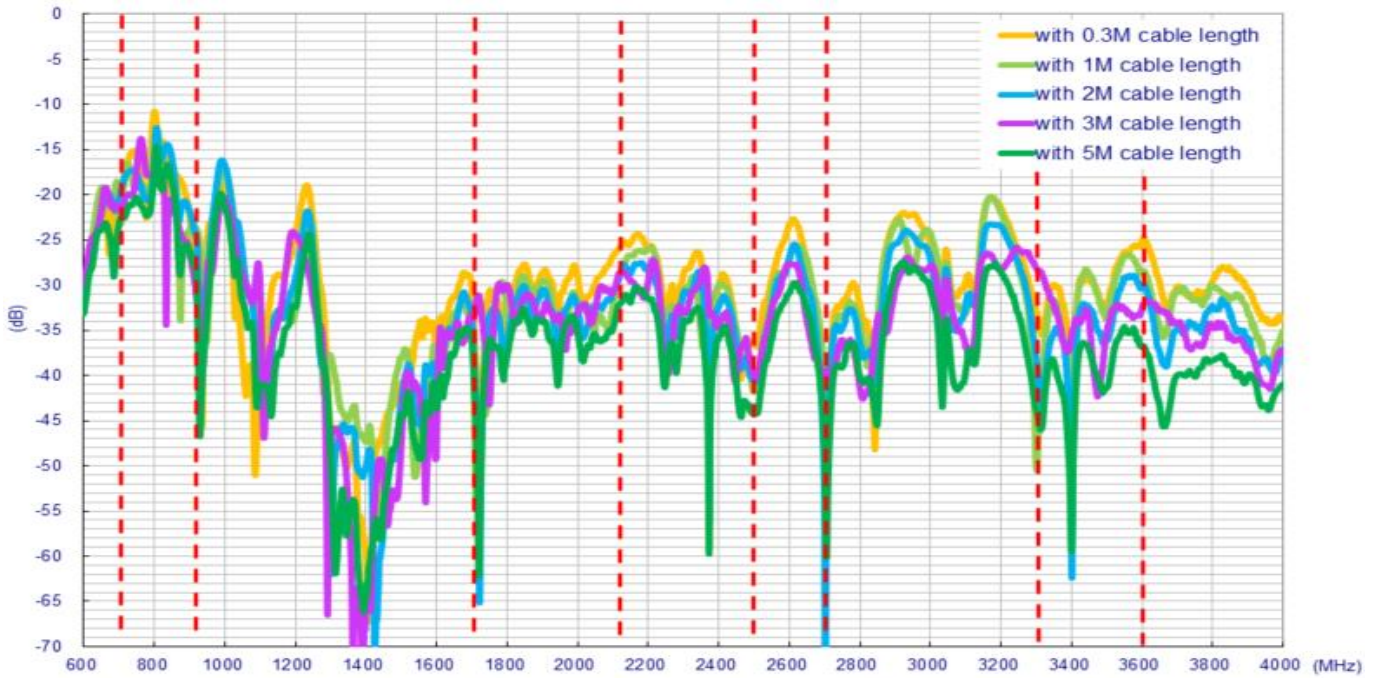

8.1.4. Efficiency (LTE MIMO_1)

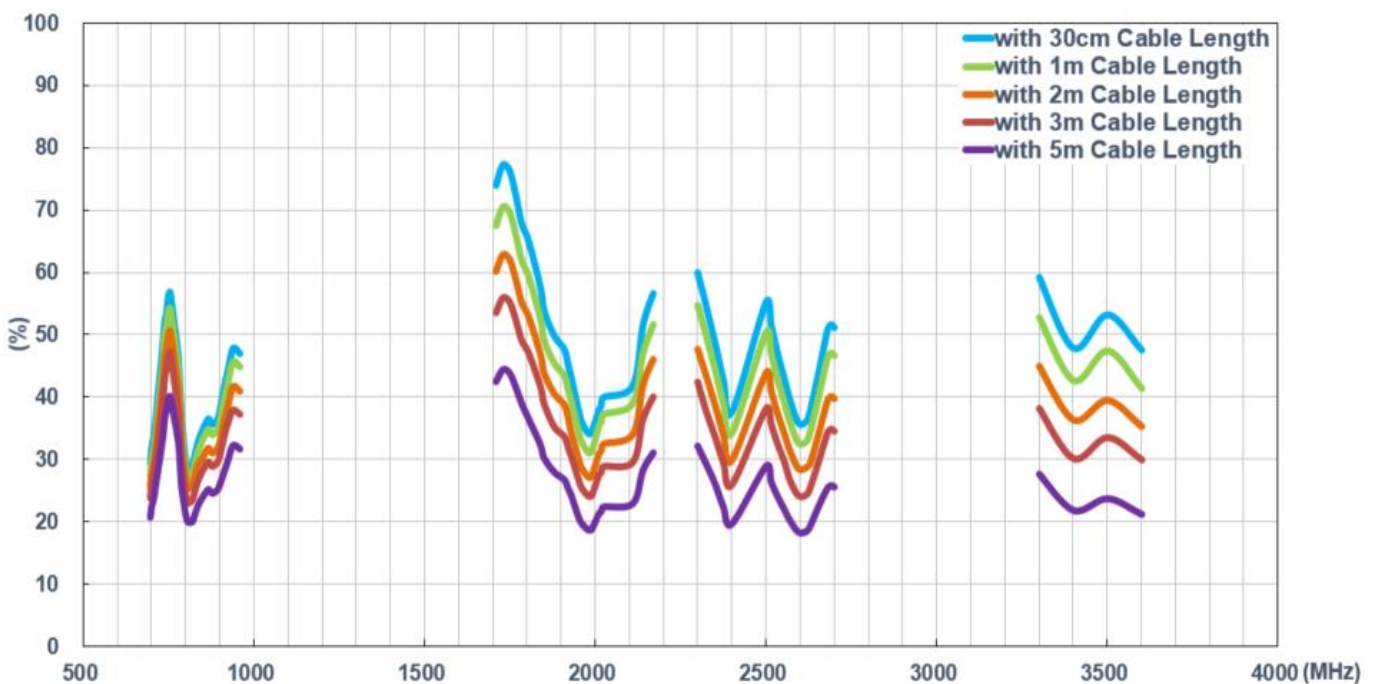

8.1.5. Efficiency (LTE MIMO_2)

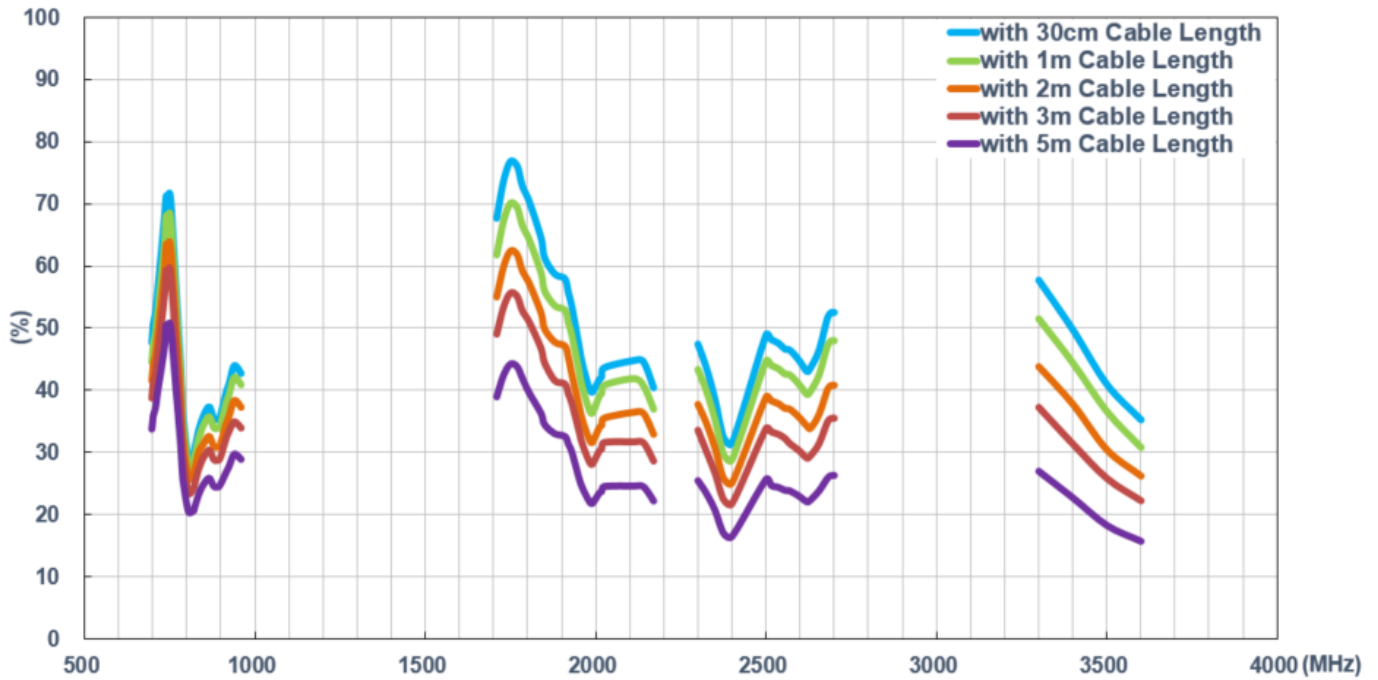

8.1.6. Average Gain (LTE MIMO_1)

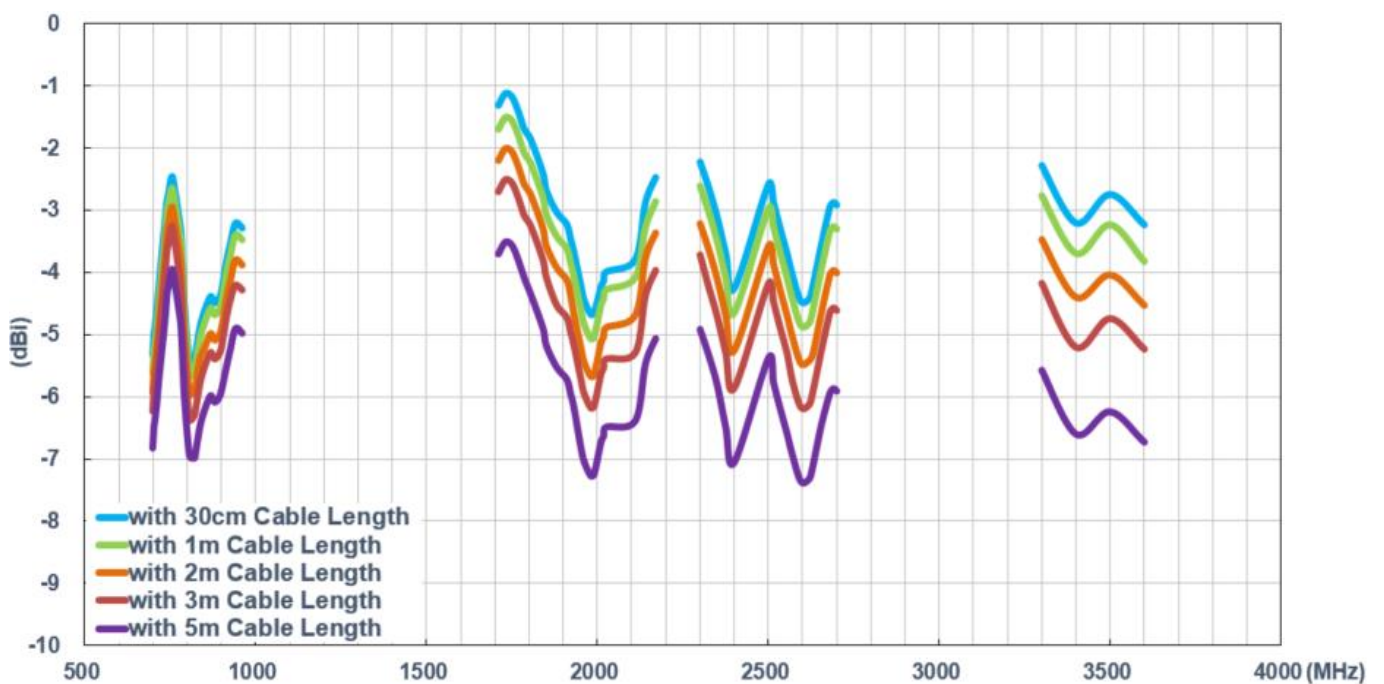

8.1.7. Average Gain (LTE MIMO_2)

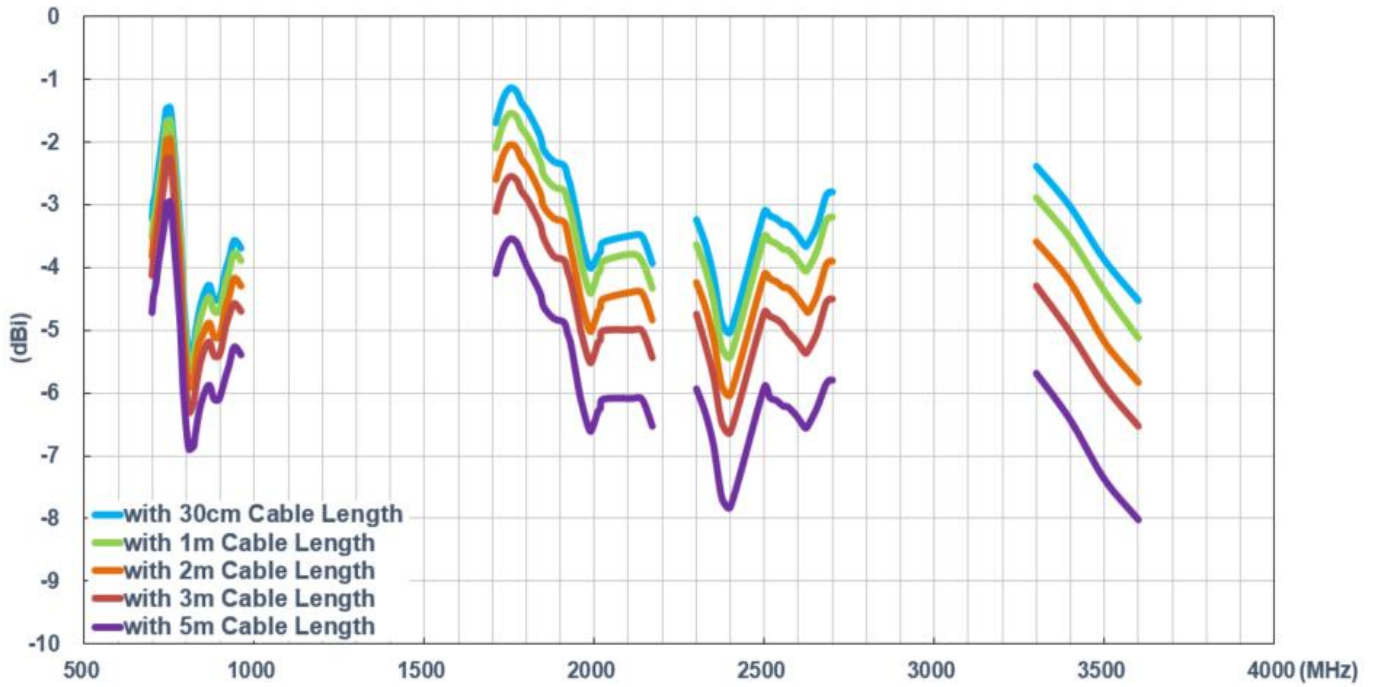

8.1.8. Peak Gain (LTE MIMO_1)

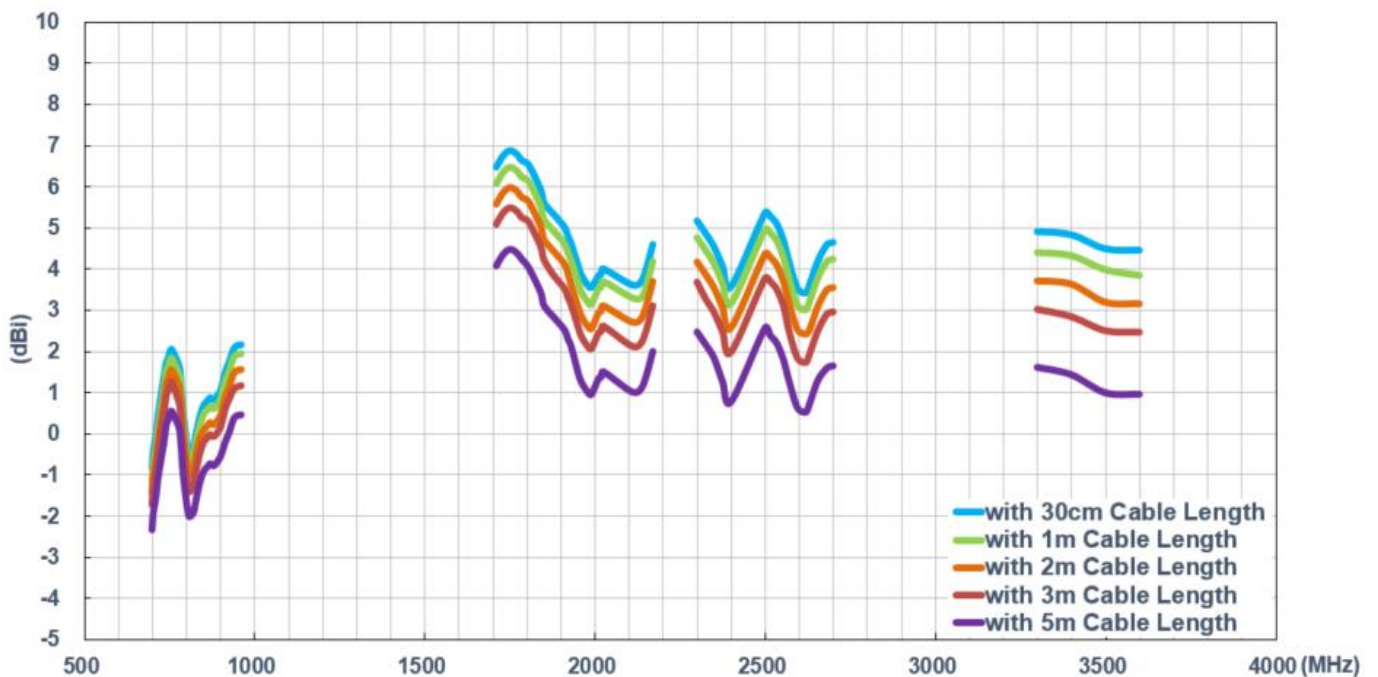

8.1.9. Peak Gain (LTE MIMO_2)

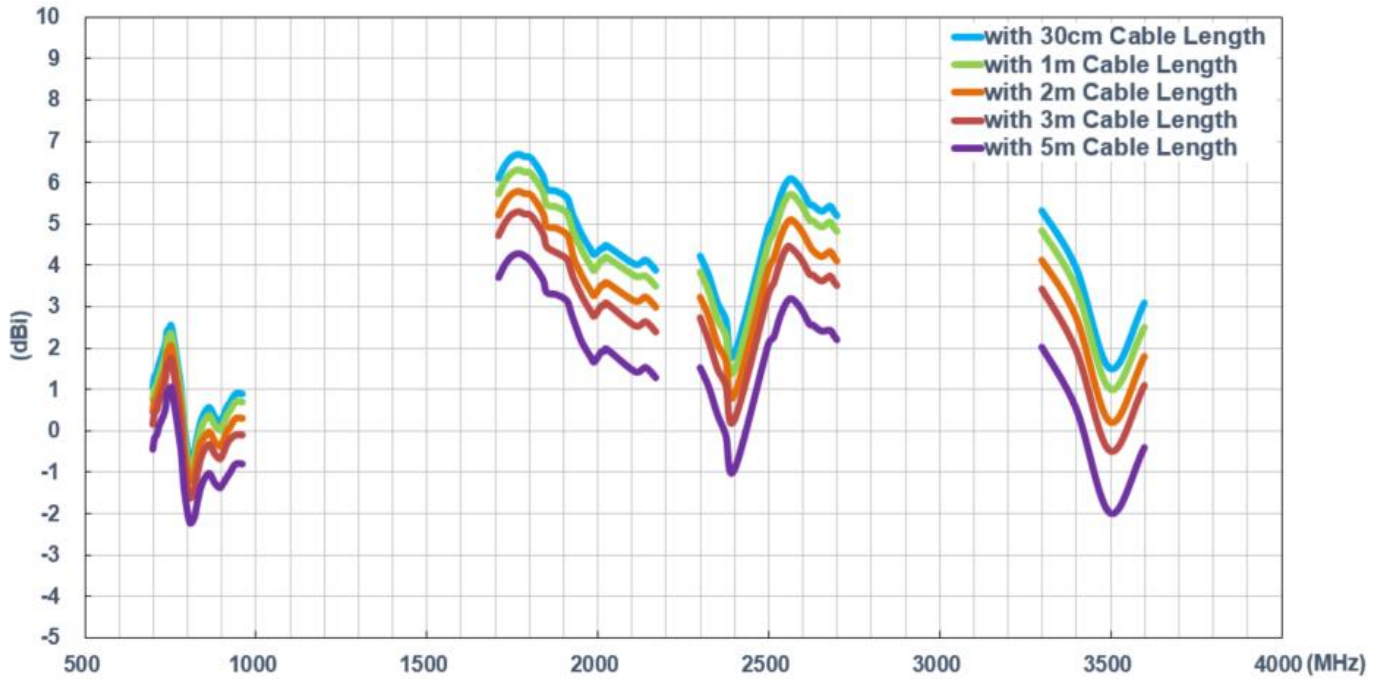

8.2. In free space (Wi-Fi Antenna)

8.2.1. Return Loss

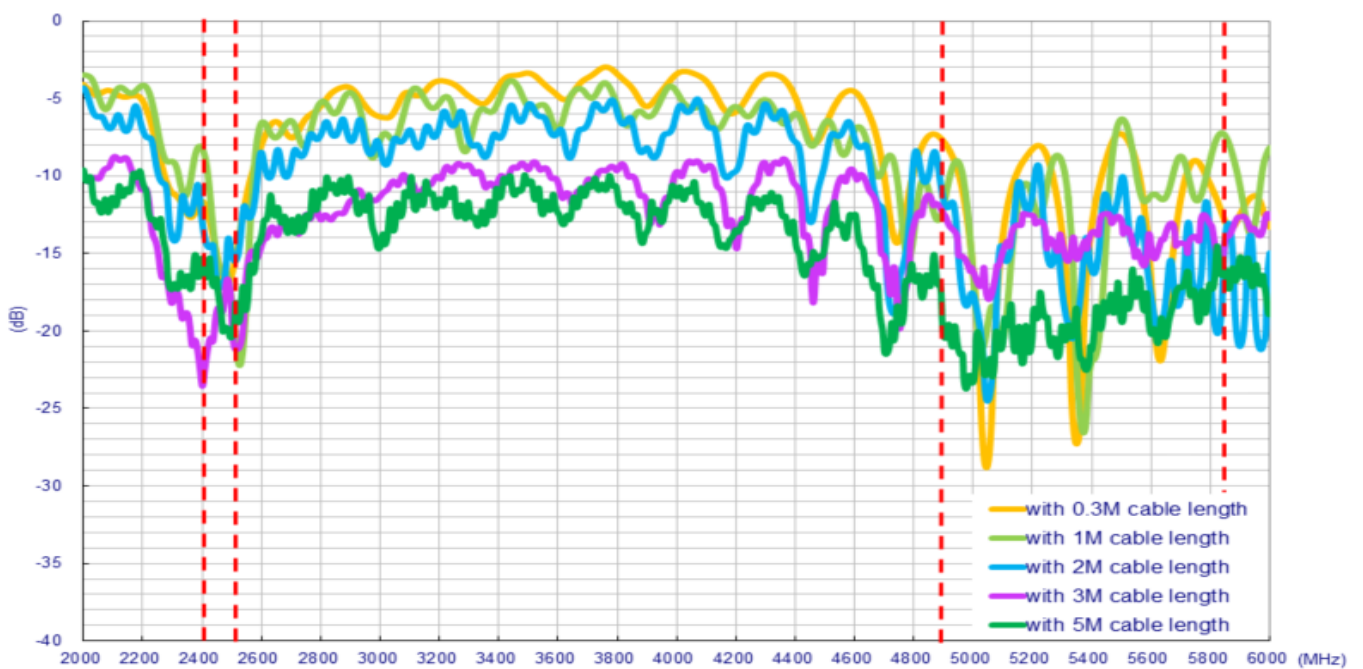

8.2.2. Efficiency (Wi-Fi)

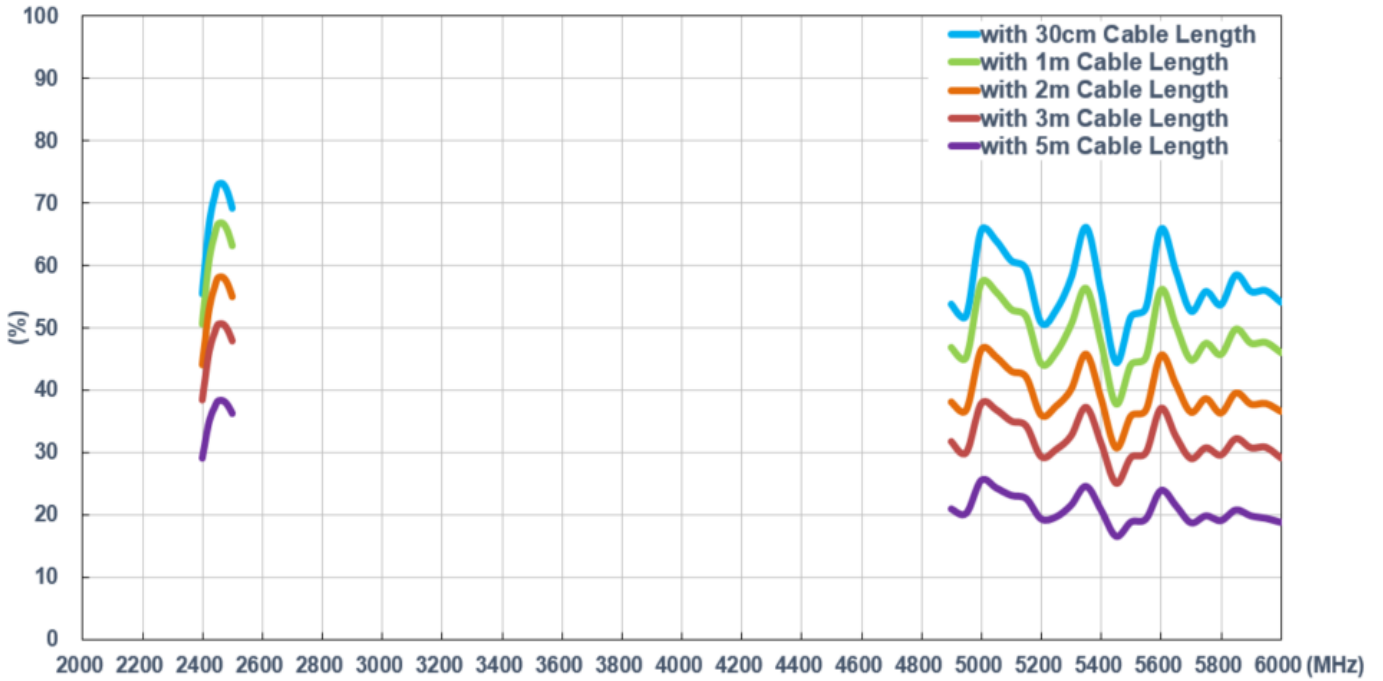

8.2.3. Average Gain (Wi-Fi)

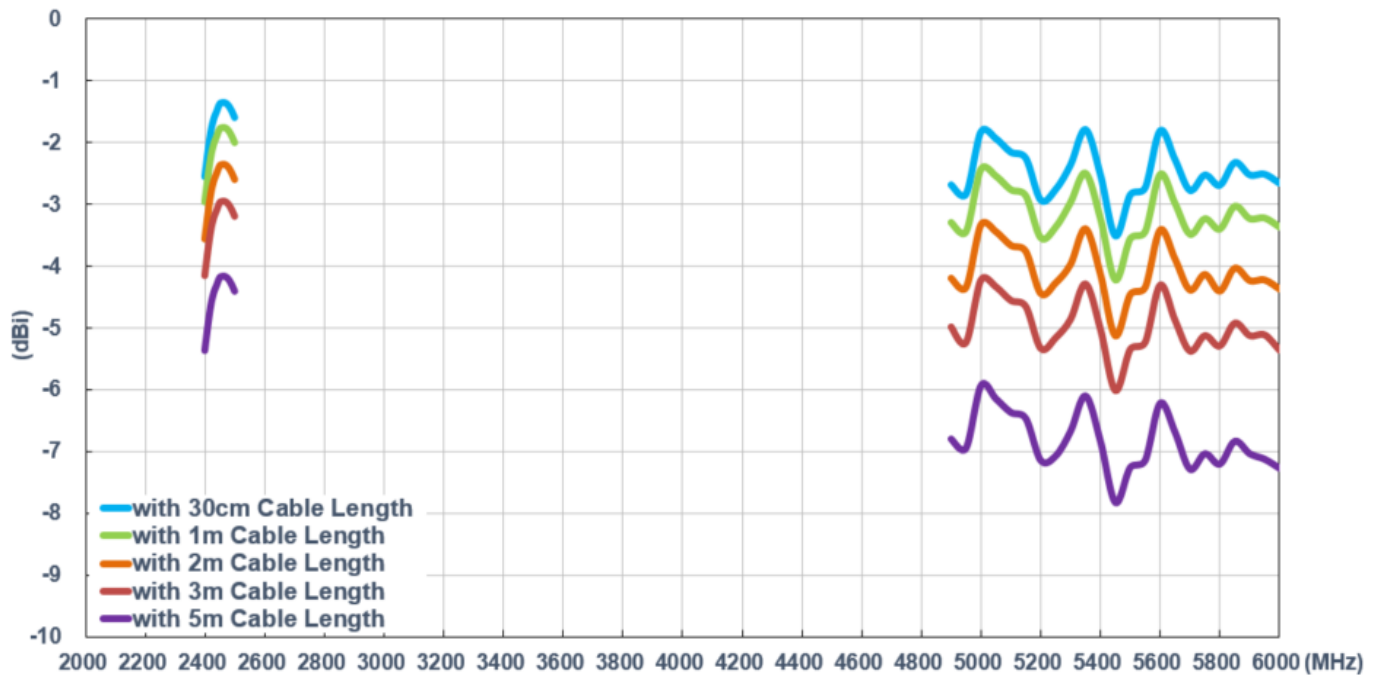

8.2.4. Peak Gain (Wi-Fi)

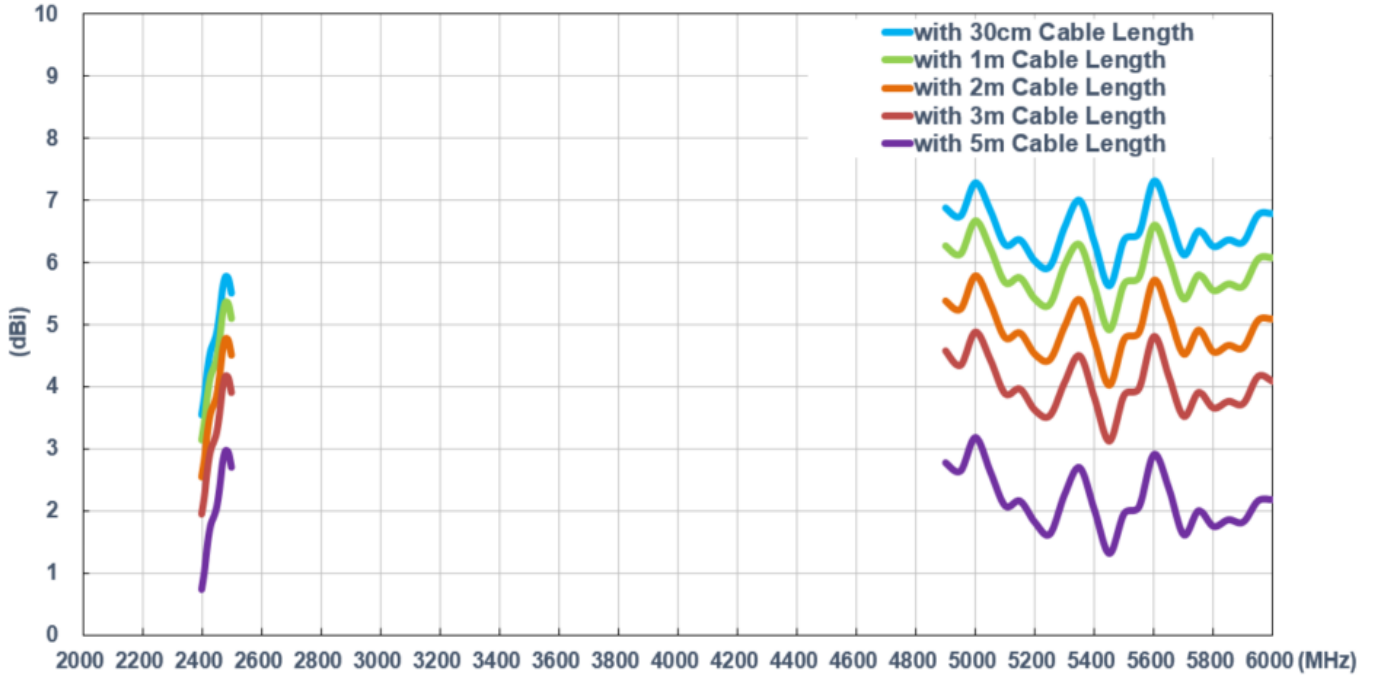

Taoglas makes no warranties based on the accuracy or completeness of the contents of this document and reserves the right to make changes to specifications and product descriptions at any time without notice. Taoglas reserves all rights to this document and the information contained herein.

Reproduction, use or disclosure to third parties without express permission is strictly prohibited.

Copyright © Taoglas Ltd.