

DESCRIPTION

This UPS1040CTe3 in the Powermite3[®] package is a high efficiency center-tap dual Schottky rectifier that is also RoHS compliant offering high current/power capabilities previously found only in much larger packages. They are ideal for SMD applications that operate at high frequencies. In addition to its size advantages, the Powermite3[®] package includes a full metallic bottom that eliminates the possibility of solder flux entrapment during assembly and a unique locking tab act as an efficient heat path to the heat-sink mounting. Its innovative design makes this device ideal for use with automatic insertion equipment.

IMPORTANT: For the most current data, consult MICROSEMI's website: <http://www.microsemi.com>

KEY FEATURES

- Very low thermal resistance package
- Dual center-tap Schottky configuration with common cathode
- RoHS Compliant with e3 suffix part number
- Guard-ring-die construction for transient protection
- Efficient heat path with Integral locking bottom metal tab
- Low forward voltage
- Full metallic bottom eliminates flux entrapment
- Compatible with automatic insertion
- Low profile-maximum height of 1mm

**ABSOLUTE MAXIMUM RATINGS AT 25° C
(UNLESS OTHERWISE SPECIFIED)**

Rating	Symbol	Value	Unit
Peak Repetitive Reverse Voltage Working Peak Reverse Voltage DC Blocking Voltage	V_{RRM} V_{RWM} V_R	40	V
RMS Reverse Voltage	$V_{R(RMS)}$	28	V
Average Rectified Output Current	I_o	10	A
Non-Repetitive Peak Forward Surge Current 8.3ms Single half sine wave Superimposed on Rated Load@ $T_c = 90^\circ\text{C}$	I_{FSM}	150	A
Storage Temperature	T_{STG}	-55 to +150	°C
Junction Temperature	T_J	-55 to +125	°C

APPLICATIONS/BENEFITS

- Switching and Regulating Power supplies.
- Silicon Schottky (hot carrier) rectifier for minimal reverse voltage recovery
- Elimination of reverse-recovery oscillations to reduce need for EMI filtering
- Charge Pump Circuits
- Reduces reverse recovery loss with low I_{RM}
- Small foot print  = 190 X 260 mils (1:1 Actual size)
See mounting pad details on pg 5

MECHANICAL & PACKAGING

- CASE: Void-free transfer molded thermosetting epoxy compound meeting UL94V-0
- FINISH: Annealed matte-Tin plating over copper and readily solderable per MIL-STD-750 method 2026 (consult factory for Tin-Lead plating)
- POLARITY: See figure (left)
- MARKING: S1040CT•
- WEIGHT: 0.072 gram (approx.)
- Package dimension on last page
- Tape & Reel option: 16 mm tape per Standard EIA-481-B, 5000 on 13" reel

**THERMAL CHARACTERISTICS
(UNLESS OTHERWISE SPECIFIED)**

Thermal Resistance (dual device)			
Junctions-to Bottom (Case)	$R_{\theta JC}$	2.5	°C/Watt

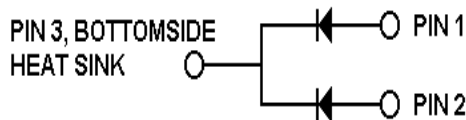
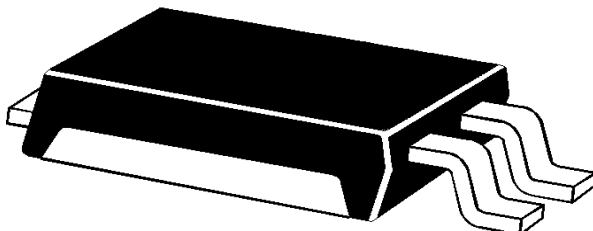

ELECTRICAL PARAMETERS @ 25°C (unless otherwise specified)

Parameter	Symbol	Conditions	Min	Typ.	Max	Units
Forward Voltage (Note 1) Per Element	V_F	$I_F = 5\text{ A}, T_J = 25\text{ °C}$ $I_F = 5\text{ A}, T_J = 100\text{ °C}$ $I_F = 10\text{ A}, T_J = 25\text{ °C}$ $I_F = 10\text{ A}, T_J = 100\text{ °C}$		0.44 0.39 0.51 0.50	0.48 0.42 0.57 0.55	V
Reverse Breakdown Voltage (Note 1)	V_{BR}	$I_R = 500\text{ }\mu\text{A}$	40			V
Reverse Current (Note1) Per Element	I_R	$V_R = 35\text{ V}, T_J = 25\text{ °C}$ $V_R = 35\text{ V}, T_J = 100\text{ °C}$ $V_R = 17.5\text{ V}, T_J = 25\text{ °C}$ $V_R = 17.5\text{ V}, T_J = 100\text{ °C}$		35 4 15 2	150 10 80 5	μA mA μA mA
Capacitance Per Element	C_T	$V_R = 4\text{ V}; f = 1\text{ MHz}$		375		pF

Note: 1 Short duration test pulse used to minimize self-heating effect

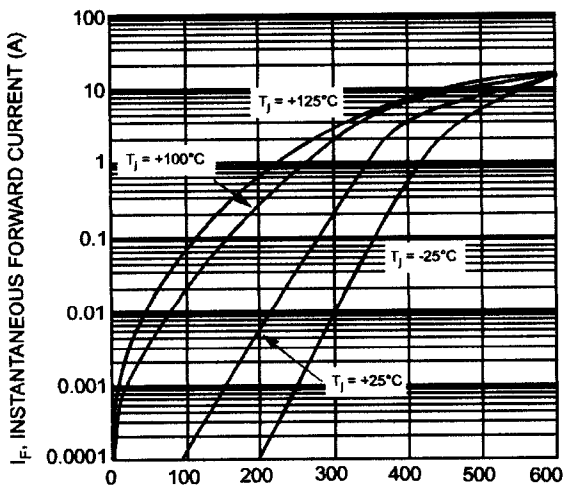
GRAPHS

V_F , INSTANTANEOUS FORWARD VOLTAGE (mV)
Fig. 1 Typical Forward Characteristics, Per Element

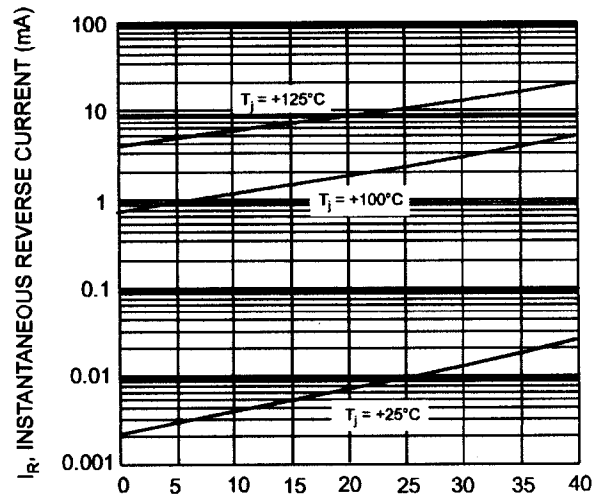

V_R , INSTANTANEOUS REVERSE VOLTAGE (V)
Fig. 2 Typical Reverse Characteristics, Per Element

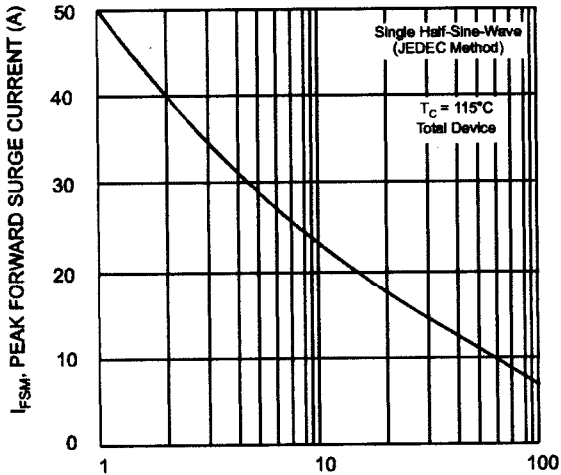

Fig. 3 Max Non-Repetitive Peak Fwd Surge Current

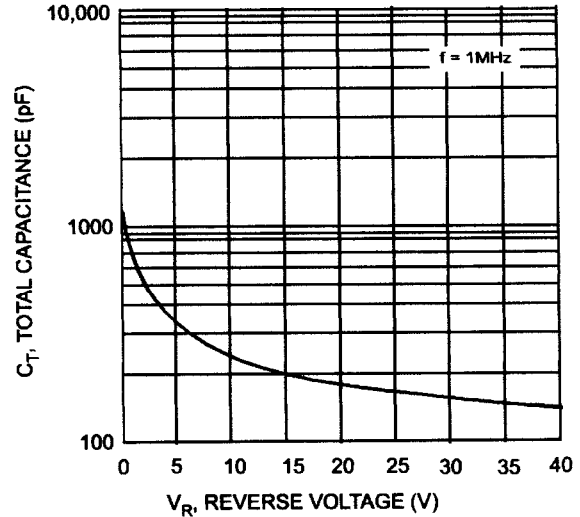

Fig. 4 Typical Capacitance vs. Reverse Voltage, Per Element

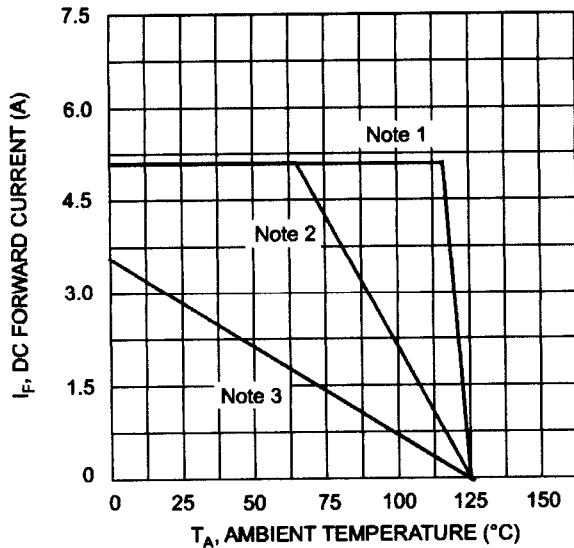

Fig. 5 DC Forward Current Derating

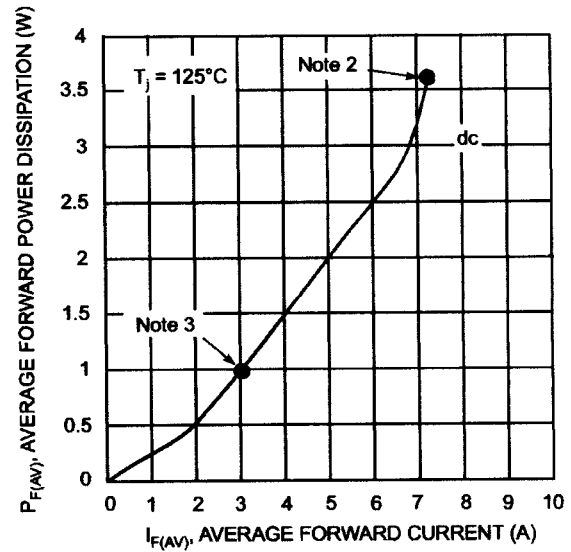
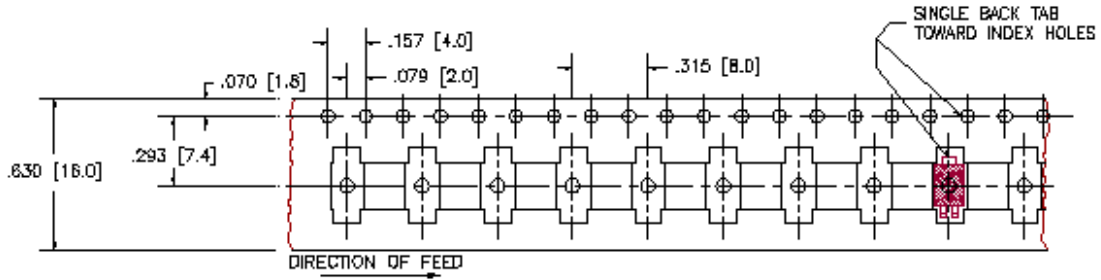
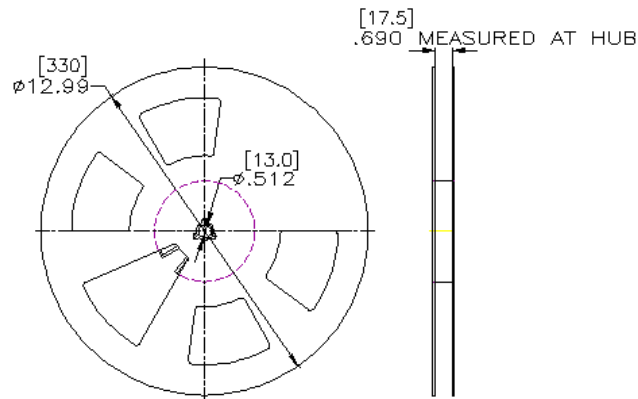

Fig. 6 Forward Power Dissipation

- NOTE 1: $T_A = T_C$ at case bottom where $R_{\theta JC} = 2.5^\circ \text{C/W}$ (dual device) and $R_{\theta CA} = 0^\circ \text{C/W}$ (infinite heat sink).
- NOTE 2: Device mounted on GETEK substrate, 2" x 2", 2 oz. copper, double-sided, cathode pad dimensions 0.75" x 1.0", anode pad dimensions 0.25" x 1.0". $R_{\theta JA}$ in range of 20-35° C/W.
- NOTE 3: Device mounted on FRA-4 substrate, 2" x 2", 2 oz. copper, single-sided, pad layout $R_{\theta JA}$ in range of 65° C/W. See mounting pad dimensions on page 5.

TAPE & REEL
16 mm TAPE

13 INCH REEL

PACKAGE & PAD LAYOUT DIMENSIONS
PACKAGING:

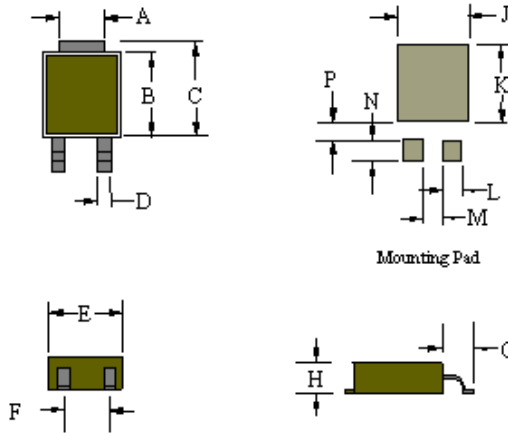
DIM	INCHES	MILLIMETERS
	NOMINAL	NOMINAL
A	0.070	1.778
B	0.173	4.392
C	0.200	5.080
D	0.035	0.889
E	0.160	4.064
F	0.072	1.829
G	0.056	1.422
H	0.044	1.118
J	0.190	4.826
K	0.210	5.344
L	0.038	0.965
M	0.034	0.864
N	0.030	0.762
P	0.030	0.762





UPS1040CTe3

10 A Dual Schottky Barrier Rectifiers

NOTES: